

ACCESSOIRES EST PERSONNALISATION

ACCESSORIES AND PARTICULAR FITTINGS

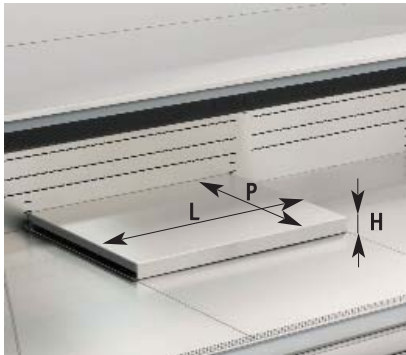

MAXIMA VOLUM
MAXIMA VOLUM PREMIUM
MAXIMA MODULAR
MAXIMA MODULAR PREMIUM
CANOVA PERFORM
MAXIMA MODULAR PS
MAXIMA MODULAR SV

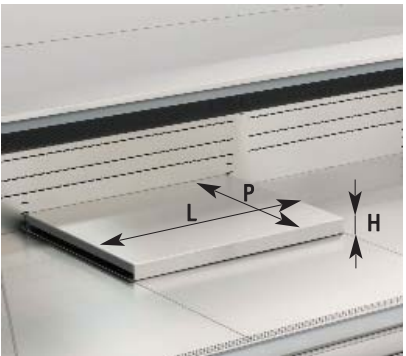
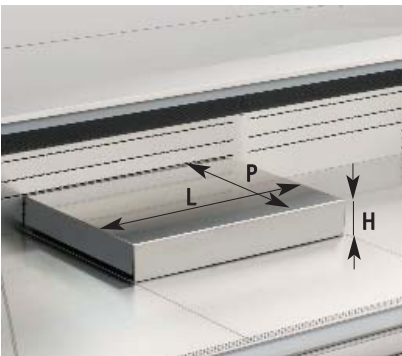
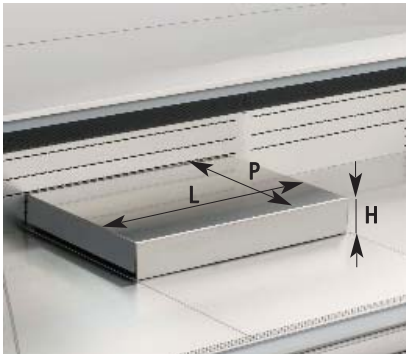
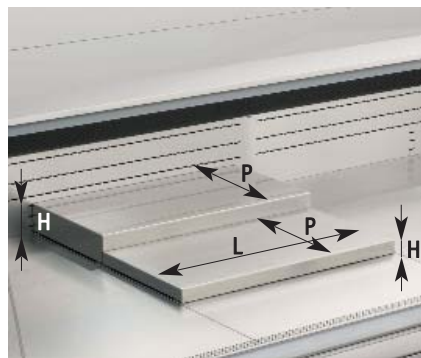
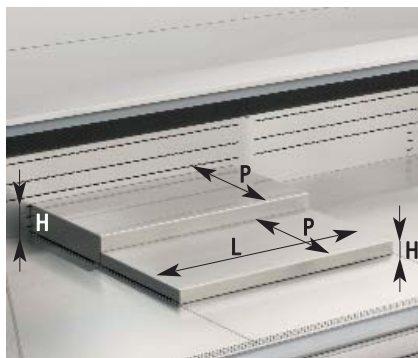
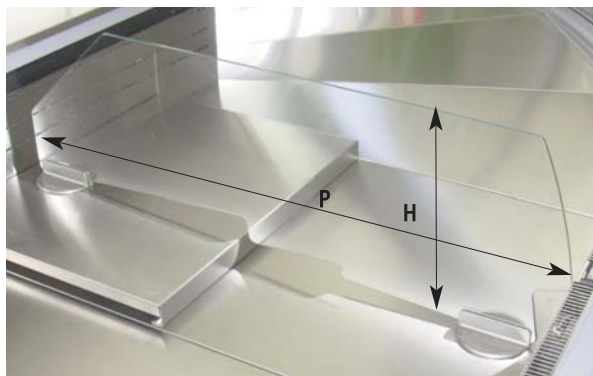



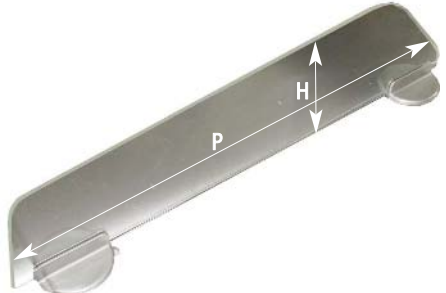
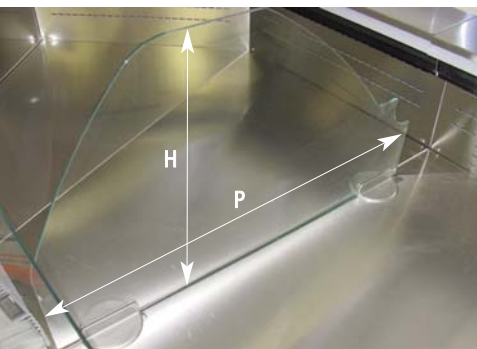
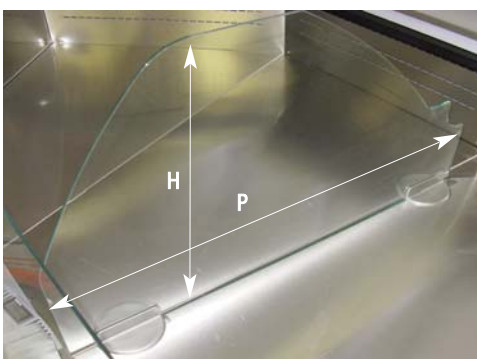
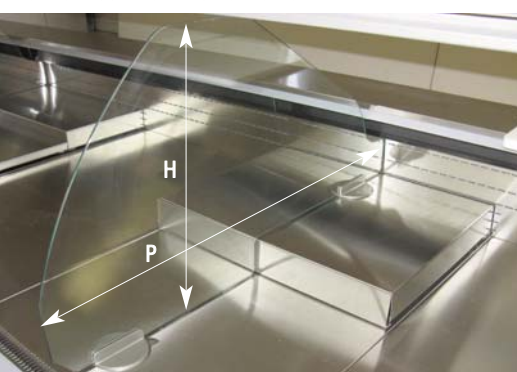

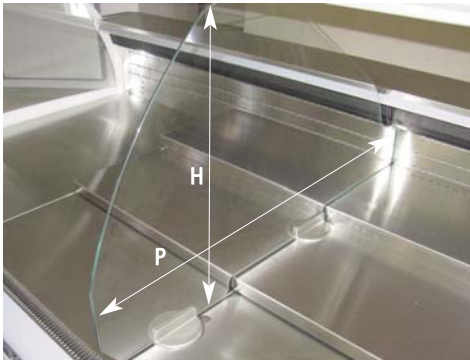
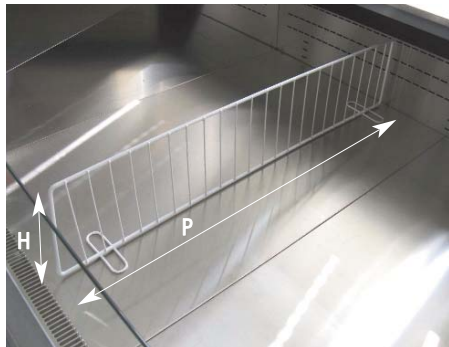
PHOTO/DRAWING	USAGE/USE		Dimensions Dimensions	NOTES
	Long./Lenght	Code		
<p>PROFIL PORTE-ACCESSOIRES (obligatoire pour LC e RBC) ACCESSORIES RAIL (compulsory for LC and DC)</p> 	<p>93 125 250 375 MAA45 MAC45 MAA90</p>	<p>3V5121 3V5122 3V5126 3V5128 3V578A 3V578B 3V578C</p>		
<p>PLATEAU INOX 2NIV. H40 ST. STEEL DISPLAY TRAY 2L H40</p> 	<p>93 125 250 375 MAA45 MAC45 MAA90</p>	<p>3M0159 3M0158 3M0158 3M0158 3V670A 3V670B 3V670C</p>	<p>LxPxH (mm) 465x480x40 620x480x40 P = 480</p>	<p>kit 93 step 93 kit kit 125 step 125 kit 1 dx + 1 sx</p>
<p>PLATEAU PEINT 2NIV. H40 PAINTED DISPLAY TRAY 2L H40</p> 	<p>93 125 250 375 MAA45 MAC45 MAA90</p>	<p>3M0099 3M3098 3M3098 3M3098 3V673A 3V673B 3V673C</p>	<p>LxPxH (mm) 465x480x40 620x480x40 P = 480</p>	<p>kit 93 step 93 kit kit 125 step 125 kit 1 dx + 1 sx</p>
<p>PLATEAU INOX 2NIV. H90 ST. STEEL DISPLAY TRAY 2L H90</p> 	<p>93 125 250 375 MAA45 MAC45 MAA90</p>	<p>3M0179 3M0178 3M3098 3M3098 3V671A 3V671B 3V671C</p>	<p>LxPxH (mm) 466x480x90 620x480x90 P = 480</p>	<p>kit 93 step 93 kit kit 125 step 125 kit 1 dx + 1 sx</p>
<p>mission: MKT</p>	<p>Code:QAP000101A</p>	<p>Rev.: 0</p>	<p>Date: 23.09.09</p>	<p>Chapitre/Chapter: 1</p>

PHOTO/DRAWING	USAGE/USE		Dimensions Dimensions	NOTES
	Long./Lenght	Code		
<p>PLATEAU PEINT 2NIV. H90 PAINTED DISPLAY TRAY 2L H90</p> 	<p>93 125 250 375</p> <p>MAA45 MAC45 MAA90</p>	<p>3M3109 3M3108 3M3108 3M3108</p> <p>3V674A 3V674B 3V675C</p>	<p>LxPxH (mm) 465x480x90 620x480x90 P = 480</p>	<p>kit 93 step 93 kit kit 125 step 125 kit 1 dx + 1 sx</p>
<p>PLATEAU INOX 3NIV. ST. STEEL DISPLAY TRAY 3L</p> 	<p>93 125 250 375</p> <p>MAA45 MAC45 MAA90</p>	<p>3M0809 3M0808 3M0808 3M0808</p> <p>3V672A 3V672B 3V672C</p>	<p>LxPxH (mm) 465x320x35 465x320x75 620x320x35 620x320x75 P = 320</p>	<p>kit 93 step 93 kit kit 125 step 125 kit 1 dx + 1 sx</p>
<p>PLATEAU PEINT 3NIV. PAINTED DISPLAY TRAY 3L</p> 		<p>3M3119 3M3118 3M3118 3M3118</p> <p>3V675A 3V675B 3V675C</p>	<p>LxPxH (mm) 465x320x35 465x320x75 620x320x35 620x320x75 P = 320</p>	<p>kit 93 step 93 kit kit 125 step 125 kit 1 dx + 1 sx</p>
<p>SEPARATION BASSE EN VERRE LOW GLASS DIVIDER</p> 		<p>TT 3V5509</p>	<p>PxH (mm) 935x310</p>	
<p>mission: MKT</p>	<p>Code:QAP000101A</p>	<p>Rev.: 0</p>	<p>Date: 23.09.09</p>	<p>Chapitre/Chapter: 1</p>

PHOTO/DRAWING	USAGE/USE		Dimensions Dimensions	NOTES
	Long./Lenght	Code		
<p>SEPARATION BASSE EN VERRE H200 LOW GLASS DIVIDER H200</p> 	TT	3V4899	PxH (mm) 955x200	
<p>SEPAR. HAUTE VERRE LC HIGH GLASS DIVIDER LC</p> 	TT	3V4895	PxH (mm) 965x590	seul LC LC only
<p>SEPAR. HAUTE VERRE DC-LS HIGH GLASS DIVIDER DC-LS</p> 	TT	3V4896	PxH (mm) 1035x590	seul DC-LS DC-LS only
<p>SEPAR. HAUTE VERRE LC-DC-LS 2NIV. HIGH GLASS DIVIDER LC-DC-LS 2L</p> 	TT	3V4897	PxH (mm) 965x590	
<p>mission: MKT</p>	Code:QAP000101A	Rev.: 0	Date: 23.09.09	Chapitre/Chapter: 1

PHOTO/DRAWING	USAGE/USE		Dimensions Dimensions	NOTES
	Long./Lenght	Code		
<p>SEPAR. HAUTE VERRE LC-DC-LS 3L HIGH GLASS DIVIDER LC-DC-LS 3L</p> 	TT	3V4898	PxH (mm) 965x590	
<p>SEPARATION FIL PLASTIFIE LS WIRE DIVIDER LS</p> 	TT	blanche/white 3M1065 couleur/colour	PxH (mm) 930x195	seul LS LS only
<p>SEPARATION 2-3 NIV. FIL PLASTIFIE WIRE PAINTED DIVIDER 2-3 LEVELS</p> 	TT	blanche/white 3V5512 couleur/colour 3V5513	PxH (mm) 935x195	
<p>RIDEAU DE NUIT LS NIGHT BLIND LS</p> 	93 125 250 375	3M0971 3M0972 3M0976 3M0978		seul LS LS only
mission: MKT	Code:QAP000101A	Rev.: 0	Date: 23.09.09	Chapitre/Chapter: 1

PHOTO/DRAWING	USAGE/USE		Dimensions Dimensions	NOTES
	Long./Lenght	Code		
TABLETTE INTERMEDIAIRE LC MIDDLE SHELF LC 	93 125 250 375	3V4391 3V4392 3V4396 3V4398	P = 235 mm	seul LC LC only
1/2 TABLETTE INTERMEDIAIRE LC SX 1/2 MIDDLE SHELF LC LEFT 	250 375	3V4400 3V4404	P = 235 mm	seul LC RAC only
1/2 TABLETTE INTERMEDIAIRE LC DX 1/2 MIDDLE SHELF LC RIGHT 	250 375	3V4401 3V4405	P = 235 mm	seul LC LC only
CLAYETTE DE CUVE LS PLASTICIZED BOTTOM GRILLES LS 	93 125 250 375 MAA45 MAC45 MAA90	3M1101 3M1102 3M1106 3M1108 3V552A 3V552B 3V552C	LxP (mm) 925x960 620x960 P = 960	seul LS LS only
.mission: MKT	Code:QAP000101A	Rev.: 0	Date: 23.09.09	Chapitre/Chapter: 1

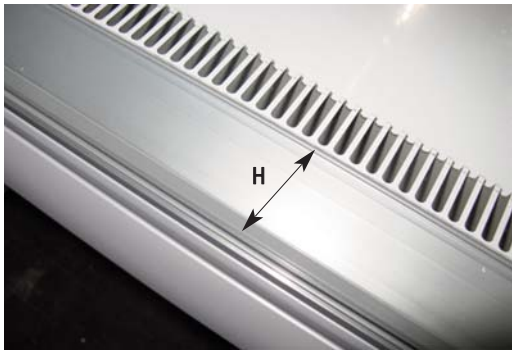
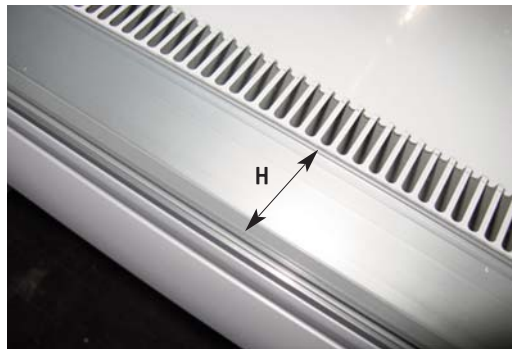
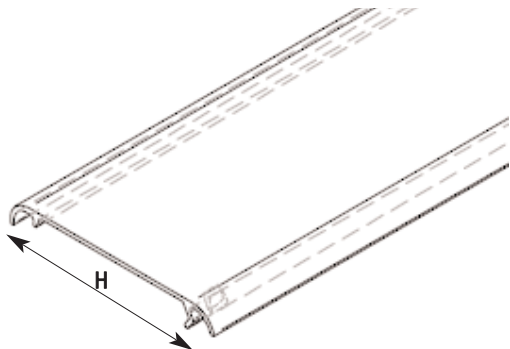

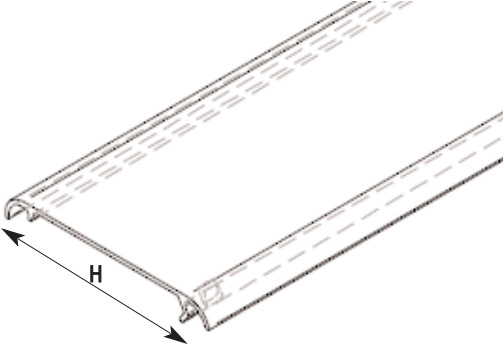
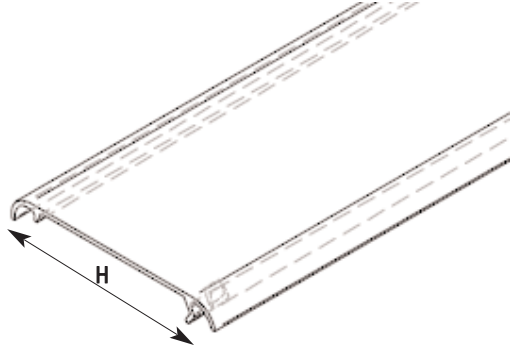
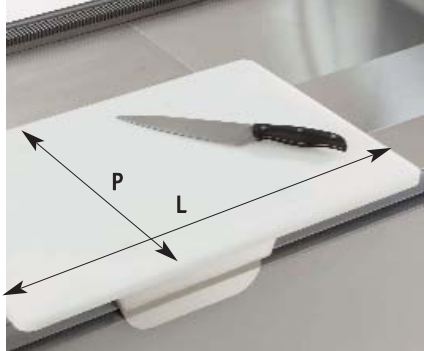
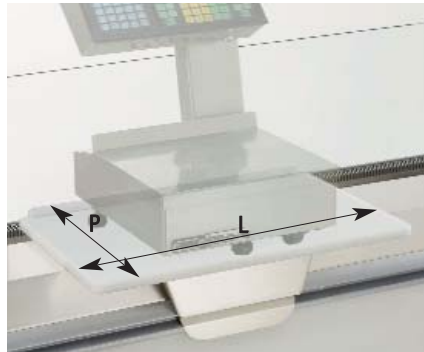
PHOTO/DRAWING	USAGE/USE		Dimensions Dimensions	NOTES
	Long./Lenght	Code		
<p>CLAYETTE DE CUVE COULEUR LS PAINTED BOTTOM GRILLES LS</p> 	<p>93 125 250 375</p> <p>MAA45 MAC45 MAA90</p>	<p>3M2201 3M2202 3M2206 3M2208</p> <p>3V553A 3V553B 3V553C</p>	<p>LxP (mm) 925x960 620x960 P = 960</p>	<p>seul LS LS only</p>
<p>PORTE AFFICHETTE LC TICKET HOLDER LC</p> 	<p>93 125 250 375</p>	<p>3V5571 3V5572 3V5576 3V5578</p>	<p>H = 40 mm</p>	<p>seul LC LC only</p>
<p>PORTE AFFICHETTE DC TICKET HOLDER DC</p> 	<p>93 125 250 375</p>	<p>3V5581 3V5582 3V5586 3V5588</p>	<p>H = 40 mm</p>	<p>seul DC DC only</p>
<p>COUVERTURE PORTE AFFICHETTE LC-DC-LS V.C. TICKET HOLDER COVER LC-DC-LS V.C.</p> 	<p>93 125</p>	<p>3V1831 3V1832</p>	<p>H = 52 mm</p>	
<p>Mission: MKT</p>	<p>Code:QAP000101A</p>	<p>Rev.: 0</p>	<p>Date: 23.09.09</p>	<p>Chapitre/Chapter: 1</p>



PHOTO/DRAWING	USAGE/USE		Dimensions Dimensions	NOTES
	Long./Lenght	Code		
<p>COUVERTURE PORTE AFFICHETTE LC V.C. TICKET HOLDER COVER LC V.C.</p> 	<p>125 250 375</p>	<p>3V1834 3V1836 3V1838</p>	<p>H = 52 mm</p>	<p>seul LC LC only</p>
<p>COUVERTURE PORTE AFFICHETTE DC-LS V.C. TICKET HOLDER COVER LC-LS V.C.</p> 	<p>125 250 375</p>	<p>3V1824 3V1826 3V1828</p>	<p>H = 52 mm</p>	<p>seul DC-LS DC-LS only</p>
<p>PLANCE A DECOUPER (ERGONOMIQUE) 170 mm CUTTING BOARD ERGONOMIC SHELF 170 mm</p> 	<p>TT</p>	<p>3V5560</p>	<p>LxP (mm) 595x395</p>	
<p>SUPPORT BALANCE (ERGONOMIQUE) 170 mm SCALE STAND ERGONOMIC SHELF 170 mm</p> 	<p>TT</p>	<p>3V5561</p>	<p>LxP (mm) 595x395</p>	
<p>mission: MKT</p>	<p>Code:QAP000101A</p>	<p>Rev.: 0</p>	<p>Date: 23.09.09</p>	<p>Chapitre/Chapter: 1</p>

PHOTO/DRAWING	USAGE/USE		Dimensions Dimensions	NOTES
	Long./Lenght	Code		
<p>PLANCE A DECOUPER TABLETTE AR. 210 mm CUTTING BOARD SHELF 170 mm</p> 	TT	3V5562	LxP (mm) 595x395	
<p>SUPPORT BALANCE TABLETTE AR. 210 mm SCALE STAND SHELF 210 mm</p> 	TT	3V5563	LxP (mm) 595x395	
<p>SUPPORT BALANCE TABLETTE AR. 300 mm SCALE STAND SHELF 300 mm</p> 	TT	3V5564	LxP (mm) 595x395	
<p>RENDEUR BILLETS (VITRAGE DC) TICHET DISH (DC)</p> 	TT	3V5504	LxP (mm) 300x220	seul DC DC only
mission: MKT	Code:QAP000101A	Rev.: 0	Date: 23.09.09	Chapitre/Chapter: 1

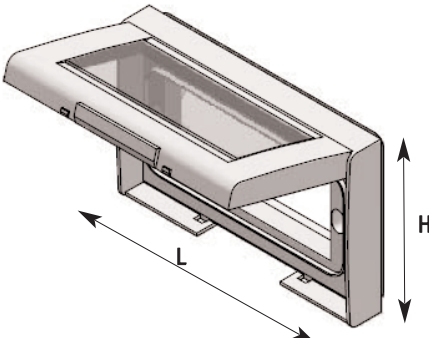

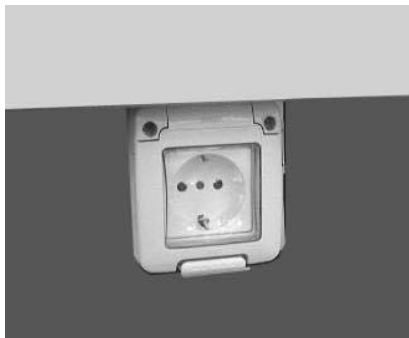
MAXIMA VOLUM

PHOTO/DRAWING	USAGE/USE		Dimensions Dimensions	NOTES
	Long./Lenght	Code		
<p>SUPPORT MONNAIE (VITRAGE DC) CHANGE DISH (DC)</p> 	TT	3V5505	LxP (mm) 300x200	seul DC DC only
<p>PORTE-COUTEAUX KNIFE HOLDER</p> 	TT	3V5568	LxPxH (mm) 410x150X410	
<p>PORTE-COUTEAUX TABLETTE AR. 300 KNIFE HOLDER REAR SHELF 300</p> 	TT	M0013200	LxPxH (mm) 410x150X410	
<p>SUPPORT PAPIER PAPER HOLDER</p> 	TT	3V5569	LxPxH (mm) 565x100X370	
.mission: MKT	Code:QAP000101A	Rev.: 0	Date: 23.09.09	Chapitre/Chapter: 1

PHOTO/DRAWING	USAGE/USE		Dimensions Dimensions	NOTES
	Long./Lenght	Code		
<p>PORTE ROULEAUX ROLL HOLDER</p> 	TT	3V5593	LxPxH (mm) 400x160X180	
<p>PROTECTION INTERRUPTEURS IP55 IP55 SWITCH PROTECTION</p> 	93 125 250 375 MAA45 MAC45 MAA90	3V3729 M0024700 3M3729 M0024700	LxH (mm) 140x90	
<p>KIT PRISE SOCKET KIT</p> 	125 250 375 250 375	3V5282 3V5283	kit 1 prise 1 socket kit kit 2 prises 2 sockets kit	
<p>KIT PRISE FRANCE E UK FRANCE AND UK SOCKET KIT</p> 	125 250 375 250 375 125 250 375 250 375	3V5284 3V5285 3V5286 3V5287	kit 1 prise 1 socket kit kit 2 prises 2 sockets kit kit 1 prise 1 socket kit kit 2 prises 2 sockets ki	seul pour France for France only seul pour France for France only seul pour UK for UK only seul pour UK for UK only
mission: MKT	Code:QAP000101A	Rev.: 0	Date: 23.09.09	Chapitre/Chapter: 1

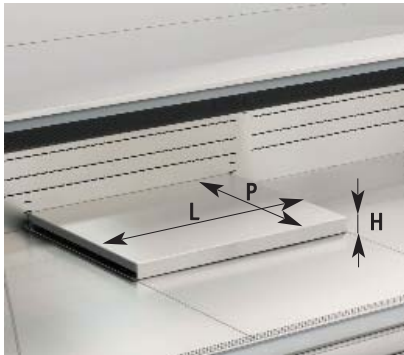
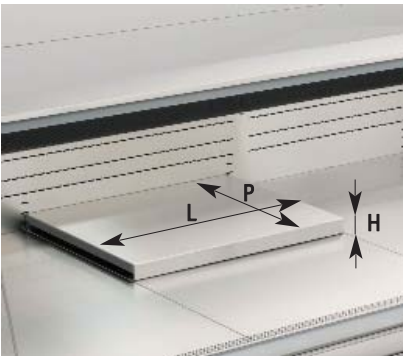
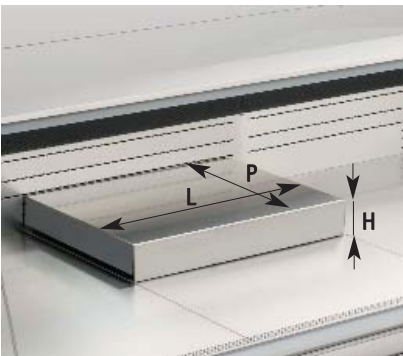

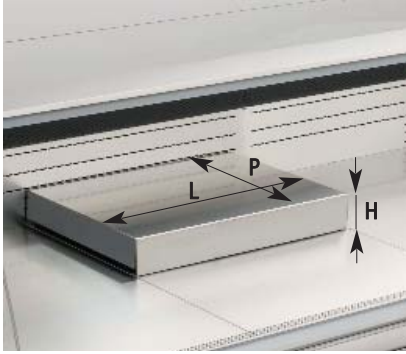
PHOTO/DRAWING	USAGE/USE		Dimensions Dimensions	NOTES
	Long./Lenght	Code		
PANNEAUX ARRIERES COULISSANTS REAR SLIDERS 	93 125 250 375 MAA45 MAC45 MAA90	3V4471 3V4472 3V4476 3V4478 3V447A 3V447B 3V447C		
PARE-CHOCS INOX ST. STEEL BUMPER RAIL 	93 125 250 375 MAA45 MAC45 MAA90	3M2271 3M2272 3M2276 3M2278 3V506A 3V506B 3V506C		
.mission: MKT	Code:QAP000101A	Rev.: 0	Date: 23.09.09	Chapitre/Chapter: 1

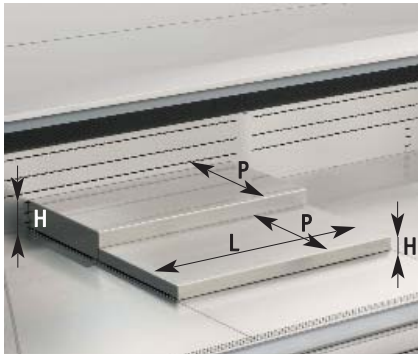
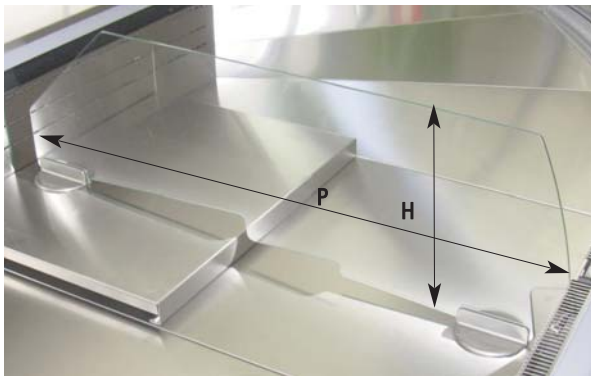
PHOTO/DRAWING	USAGE/USE		Dimensions Dimensions	NOTES
	Long./Lenght	Code		
<p>PROFIL PORTE-ACCESSOIRES (obligatoire pour RBC) ACCESSORIES RAIL (compulsory for DC)</p> 	<p>93 125 250 375 MAA45 MAC45 MAA90</p>	<p>3V5131 3V5132 3V5136 3V5138 3V579A 3V579B 3V579C</p>		
<p>PLATEAU INOX 2NIV. H40 ST. STEEL DISPLAY TRAY 2L H40</p> 	<p>93 125 250 375 MAA45 MAC45 MAA90</p>	<p>3M0159 3M0158 3M0158 3M0158 3V670A 3V670B 3V670C</p>	<p>LxPxH (mm) 465x480x40 620x480x40 P = 480</p>	<p>kit 93 step 93 kit kit 125 step 125 kit 1 dx + 1 sx</p>
<p>PLATEAU PEINT 2NIV. H40 PAINTED DISPLAY TRAY 2L H40</p> 	<p>93 125 250 375 MAA45 MAC45 MAA90</p>	<p>3M0099 3M3098 3M3098 3M3098 3V673A 3V673B 3V673C</p>	<p>LxPxH (mm) 465x480x40 620x480x40 P = 480</p>	<p>kit 93 step 93 kit kit 125 step 125 kit 1 dx + 1 sx</p>
<p>PLATEAU INOX 2NIV. H90 ST. STEEL DISPLAY TRAY 2L H90</p> 	<p>93 125 250 375 MAA45 MAC45 MAA90</p>	<p>3M0179 3M0178 3M3098 3M3098 3V671A 3V671B 3V671C</p>	<p>LxPxH (mm) 466x480x90 620x480x90 P = 480</p>	<p>kit 93 step 93 kit kit 125 step 125 kit 1 dx + 1 sx</p>

PHOTO/DRAWING	USAGE/USE		Dimensions Dimensions	NOTES
	Long./Lenght	Code		
<p>PLATEAU PEINT 2NIV. H90 PAINTED DISPLAY TRAY 2L H90</p> 	<p>93</p> <p>125</p> <p>250</p> <p>375</p> <p>MAA45</p> <p>MAC45</p> <p>MAA90</p>	<p>3M3109</p> <p>3M3108</p> <p>3M3108</p> <p>3M3108</p> <p>3V674A</p> <p>3V674B</p> <p>3V675C</p>	<p>LxPxH (mm)</p> <p>465x480x90</p> <p>620x480x90</p> <p>P = 480</p>	<p>kit 93 step 93 kit</p> <p>kit 125 step 125 kit</p> <p>1 dx + 1 sx</p>
<p>PLATEAU INOX 3NIV. ST. STEEL DISPLAY TRAY 3L</p> 	<p>93</p> <p>125</p> <p>250</p> <p>375</p> <p>MAA45</p> <p>MAC45</p> <p>MAA90</p>	<p>3M0809</p> <p>3M0808</p> <p>3M0808</p> <p>3M0808</p> <p>3V672A</p> <p>3V672B</p> <p>3V672C</p>	<p>LxPxH (mm)</p> <p>465x320x35</p> <p>465x320x75</p> <p>620x320x35</p> <p>620x320x75</p> <p>P = 320</p>	<p>kit 93 step 93 kit</p> <p>kit 125 step 125 kit</p> <p>1 dx + 1 sx</p>
<p>PLATEAU PEINT 3NIV. PAINTED DISPLAY TRAY 3L</p> 		<p>3M3119</p> <p>3M3118</p> <p>3M3118</p> <p>3M3118</p> <p>3V675A</p> <p>3V675B</p> <p>3V675C</p>	<p>LxPxH (mm)</p> <p>465x320x35</p> <p>465x320x75</p> <p>620x320x35</p> <p>620x320x75</p> <p>P = 320</p>	<p>kit 93 step 93 kit</p> <p>kit 125 step 125 kit</p> <p>1 dx + 1 sx</p>
<p>SEPARATION BASSE EN VERRE LOW GLASS DIVIDER</p> 	<p>TT</p>	<p>3V5509</p>	<p>PxH (mm)</p> <p>935x310</p>	
<p>mission: MKT</p>	<p>Code:QAP000101A</p>	<p>Rev.: 0</p>	<p>Date: 23.09.09</p>	<p>Chapitre/Chapter: 2</p>

PHOTO/DRAWING	USAGE/USE		Dimensions Dimensions	NOTES
	Long./Lenght	Code		
SEPARATION BASSE EN VERRE H200 LOW GLASS DIVIDER H200 	TT	3V4899	PxH (mm) 830x200	
SEPAR. HAUTE VERRE DC-LS HIGH GLASS DIVIDER DC-LS 	TT	3V4896	PxH (mm) 1035x590	
SEPAR. HAUTE VERRE DC-LS 2L HIGH GLASS DIVIDER DC-LS 2L 	TT	3V4897	PxH (mm) 965x590	
SEPAR. HAUTE VERRE DC 2L HIGH GLASS DIVIDER DC 2L 	TT	3M3769	PxH (mm) 840x590	
.mission: MKT	Code:QAP000101A	Rev.: 0	Date: 23.09.09	Chapitre/Chapter: 2

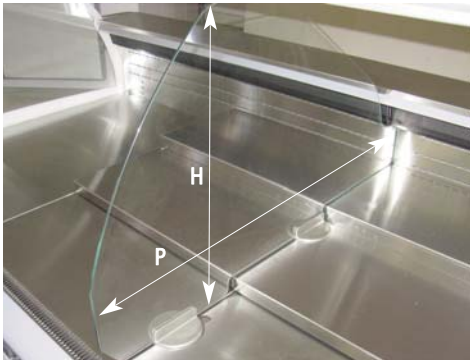
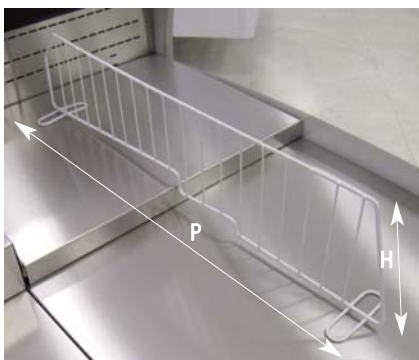
MAXIMA VOLUM PREMIUM



PHOTO/DRAWING	USAGE/USE		Dimensions Dimensions	NOTES
	Long./Lenght	Code		
SEPAR. HAUTE VERRE LC-DC-LS 3L HIGH GLASS DIVIDER LC-DC-LS 3L 	TT	3V4898	PxH (mm) 965x590	
SEPARATION FIL PLASTIFIE LS WIRE DIVIDER LS 	TT	blanche/white 3M1065 couleur/colour 3M1497	PxH (mm) 930x195	seul LS LS only
SEPARATION 2-3 NIV. FIL PLASTIFIE WIRE PAINTED DIVIDER 2-3 LEVELS 	TT	blanche/white 3V5512 couleur/colour3 V5513	PxH (mm) 935x195	
RIDEAU DE NUIT LS NIGHT BLIND LS 	93 125 250 375	3M0971 3M0972 3M0976 3M0978		seul LS LS only
mission: MKT	Code:QAP000101A	Rev.: 0	Date: 23.09.09	Chapitre/Chapter: 2



PHOTO/DRAWING	USAGE/USE		Dimensions Dimensions	NOTES
	Long./Lenght	Code		
<p>CLAYETTE DE CUVE LS PLASTICIZED BOTTOM GRILLES LS</p> 	<p>93 125 250 375</p> <p>MAA45 MAC45 MAA90</p>	<p>3M1101 3M1102 3M1106 3M1108</p> <p>3V552A 3V552B 3V552C</p>	<p>LxP (mm) 925x960 620x960 P = 960</p>	<p>seul LS LS only</p>
<p>CLAYETTE DE CUVE COULEUR LS PAINTED BOTTOM GRILLES LS</p> 	<p>93 125 250 375</p> <p>MAA45 MAC45 MAA90</p>	<p>3M2201 3M2202 3M2206 3M2208</p> <p>3V553A 3V553B 3V553C</p>	<p>LxP (mm) 925x960 620x960 P = 960</p>	<p>seul LS LS only</p>
<p>PORTE AFFICHETTE DC TICKET HOLDER DC</p> 	<p>93 125 250 375</p>	<p>3V5581 3V5582 3V5586 3V5588</p>	<p>H = 40 mm</p>	<p>seul DC DC only</p>
<p>PLANCE A DECOUPER (ERGONOMIQUE) 170 mm CUTTING BOARD ERGONOMIC SHELF 170 mm</p> 	<p>TT</p>	<p>3V5560</p>	<p>LxP (mm) 595x395</p>	
<p>mission: MKT</p>	<p>Code:QAP000101A</p>	<p>Rev.: 0</p>	<p>Date: 23.09.09</p>	<p>Chapitre/Chapter: 2</p>

MAXIMA VOLUM PREMIUM

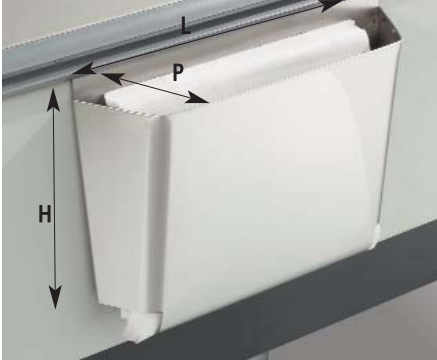
PHOTO/DRAWING	USAGE/USE		Dimensions Dimensions	NOTES
	Long./Lenght	Code		
<p>SUPPORT BALANCE (ERGONOMIQUE) 170 mm SCALE STAND ERGONOMIC SHELF 170 mm</p> 	TT	3V5561	LxP (mm) 595x395	
<p>PLANCE A DECOUPER TABLETTE AR. 210 mm CUTTING BOARD SHELF 170 mm</p> 	TT	3V5562	LxP (mm) 595x395	
<p>SUPPORT BALANCE TABLETTE AR. 210 mm SCALE STAND SHELF 210 mm</p> 	TT	3V5563	LxP (mm) 595x395	
<p>SUPPORT BALANCE TABLETTE AR. 300 mm SCALE STAND SHELF 300 mm</p> 	TT	3V5564	LxP (mm) 595x395	
mission: MKT	Code:QAP000101A	Rev.: 0	Date: 23.09.09	Chapitre/Chapter: 2

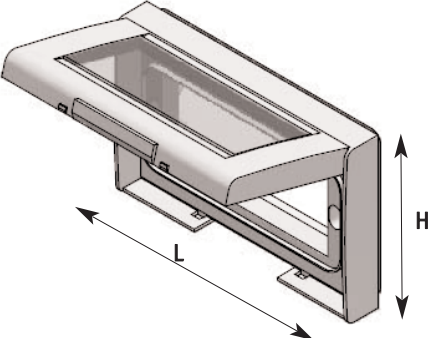
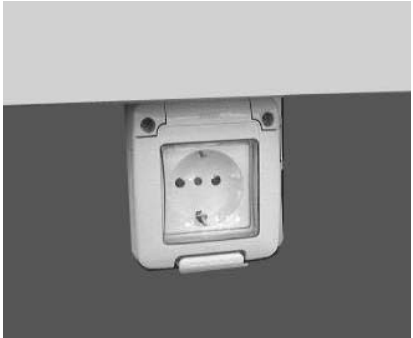
PHOTO/DRAWING	USAGE/USE		Dimensions Dimensions	NOTES
	Long./Lenght	Code		
<p>RENDEUR BILLETS (VITRAGE DC) TICHET DISH (DC)</p> 	TT	3V5504	LxP (mm) 300x220	seul DC DC only
<p>SUPPORT MONNAIE (VITRAGE DC) CHANGE DISH (DC)</p> 	TT	3V5505	LxP (mm) 300x200	seul DC DC only
<p>PORTE-COUTEAUX KNIFE HOLDER</p> 	TT	3V5568	LxPxH (mm) 410x150X410	
<p>PORTE-COUTEAUX TABLETTE AR. 300 KNIFE HOLDER REAR SHELF 300</p> 	TT	M0013200	LxPxH (mm) 410x150X410	
<p>mission: MKT</p>	Code:QAP000101A	Rev.: 0	Date: 23.09.09	Chapitre/Chapter: 2

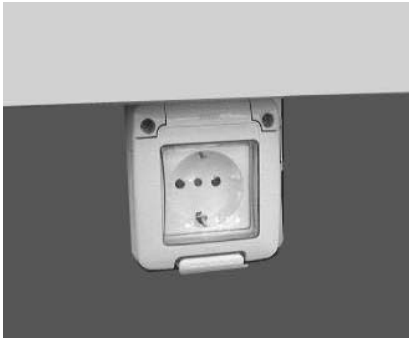
PHOTO/DRAWING	USAGE/USE		Dimensions Dimensions	NOTES
	Long./Lenght	Code		
<p>SUPPORT PAPIER PAPER HOLDER</p> 	TT	3V5569	LxPxH (mm) 565x100X370	
<p>PORTE ROULEAUX ROLL HOLDER</p> 	TT	3V5593	LxPxH (mm) 400x160X180	
<p>PROTECTION INTERRUPTEURS IP55 IP55 SWITCH PROTECTION</p> 	<p>93 125 250 375</p> <p>MAA45 MAC45 MAA90</p>	<p>3V3729</p> <p>M0024700 3M3729 M0024700</p>	LxH (mm) 140x90	
<p>KIT PRISE SOCKET KIT</p> 	<p>125 250 375</p> <p>250 375</p>	<p>3V5282</p> <p>3V5283</p>	<p>kit 1 prise 1 socket kit</p> <p>kit 2 prises 2 sockets kit</p>	
<p>mission: MKT</p>	Code:QAP000101A	Rev.: 0	Date: 23.09.09	Chapitre/Chapter: 2

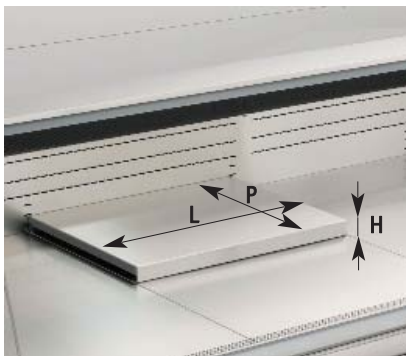
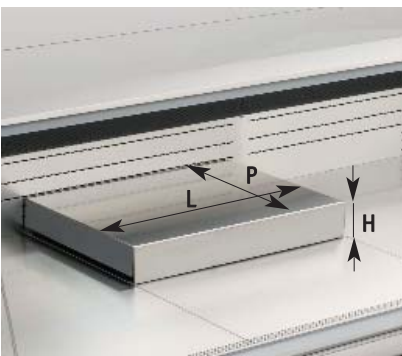

PHOTO/DRAWING	USAGE/USE		Dimensions Dimensions	NOTES
	Long./Lenght	Code		
KIT PRISE FRANCE E UK FRANCE AND UK SOCKET KIT 	125	3V5284	kit 1 prise 1 socket kit	seul pour France for France only
	250			
	375			
	250	3V5285	kit 2 prises 2 sockets kit	seul pour France for France only
375				
	125	3V5286	kit 1 prise 1 socket kit	seul pour UK for UK only
	250			
	375			
	250	3V5287	kit 2 prises 2 sockets ki	seul pour UK for UK only
375				
PARE-CHOCS INOX ST. STEEL BUMPER RAIL 	93	3M2271		
	125	3M2272		
	250	3M2276		
	375	3M2278		
	MAA45	3V506A		
	MAC45	3V506B		
	MAA90	3V506C		

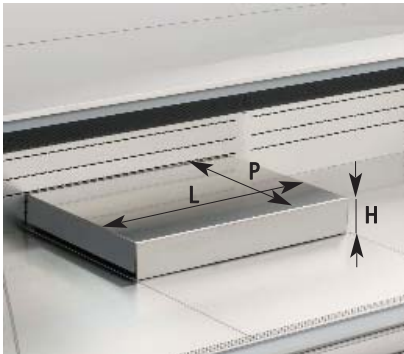
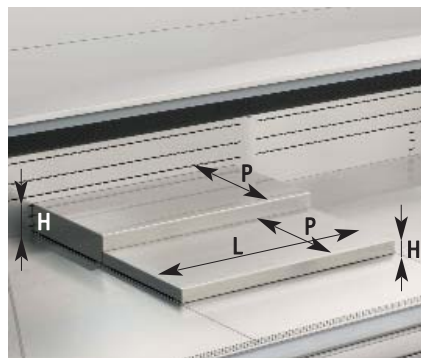
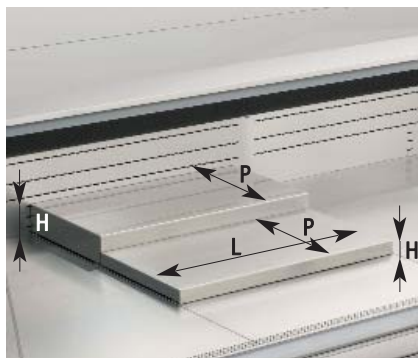
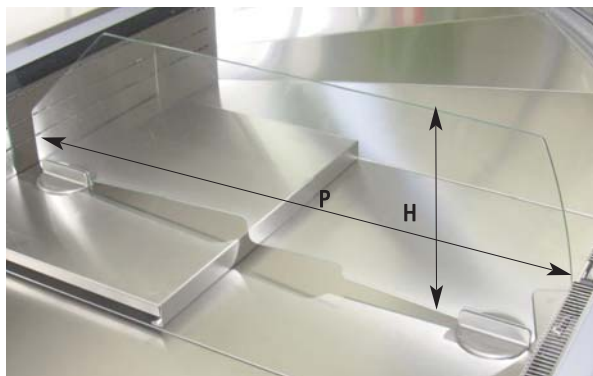
PHOTO/DRAWING	USAGE/USE		Dimensions Dimensions	NOTES
	Long./Lenght	Code		
PROFIL PORTE-ACCESSOIRES (obligatoire pour LC e RBC) ACCESSORIES RAIL (compulsory for LC and DC) 	93 125 187 250 312 375 MAA45 MAC45 MAA90	3V5121 3V5122 3V5124 3V5126 3V5127 3V5128 3V512A 3V512B 3V512C		
PLATEAU INOX 2NIV. H40 ST. STEEL DISPLAY TRAY 2L H40 	93 125 187 250 312 375 MAA45 MAC45 MAA90	3M1479 3M1478 3M1478 3M1478 3M1478 3M1478 3V676A 3V676B 3V676C	LxPxH (mm) 465x420x40 620x420x40 P = 420	kit 93 step 93 kit kit 125 step 125 kit 1 dx + 1 sx
PLATEAU PEINT 2NIV. H40 PAINTED DISPLAY TRAY 2L H40 	93 125 187 250 312 375 MAA45 MAC45 MAA90	3M3129 3M3128 3M3128 3M3128 3M3128 3M3128 3V679A 3V679B 3V679C	LxPxH (mm) 465x420x40 620x420x40 P = 420	kit 93 step 93 kit kit 125 step 125 kit 1 dx + 1 sx
PLATEAU INOX 2NIV. H90 ST. STEEL DISPLAY TRAY 2L H90 	93 125 187 250 312 375 MAA45 MAC45 MAA90	3M1489 3M1488 3M1488 3M1488 3M1488 3M1488 3V677A 3V677B 3V677C	LxPxH (mm) 465x420x40 620x420x40 P = 420	kit 93 step 93 kit kit 125 step 125 kit 1 dx + 1 sx
.mission: MKT	Code:QAP000101A	Rev.: 0	Date: 23.09.09	Chapitre/Chapter: 3

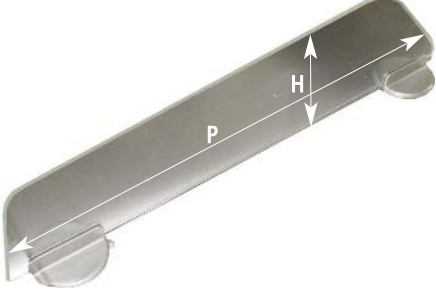
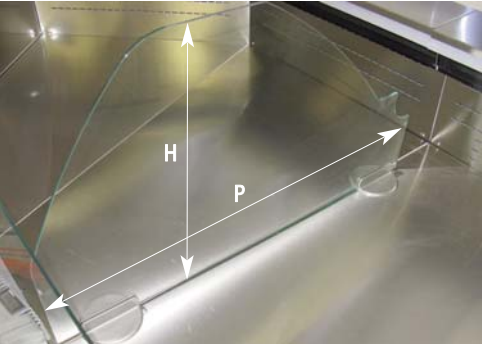
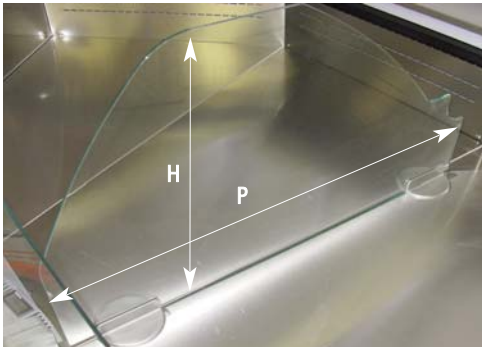
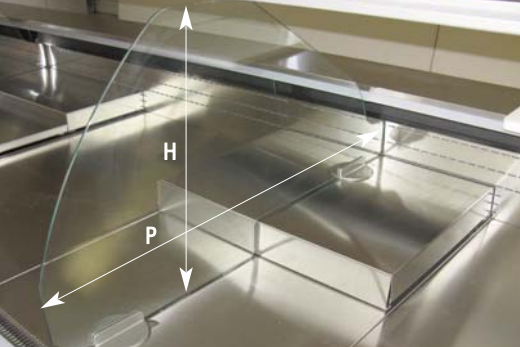
PHOTO/DRAWING	USAGE/USE		Dimensions Dimensions	NOTES
	Long./Lenght	Code		
<p>PLATEAU PEINT 2NIV. H90 PAINTED DISPLAY TRAY 2L H90</p> 	<p>93</p> <p>125</p> <p>187</p> <p>250</p> <p>312</p> <p>375</p> <p>MAA45</p> <p>MAC45</p> <p>MAA90</p>	<p>3M3139</p> <p>3M3138</p> <p>3M3138</p> <p>3M3138</p> <p>3M3138</p> <p>3M3138</p> <p>3V680A</p> <p>3V680B</p> <p>3V680C</p>	<p>LxPxH (mm)</p> <p>465x420x40</p> <p>620x420x40</p> <p>P = 420</p>	<p>kit 93 step 93 kit</p> <p>kit 125 step 125 kit</p> <p>1 dx + 1 sx</p>
<p>PLATEAU INOX 3NIV. ST. STEEL DISPLAY TRAY 3L</p> 	<p>93</p> <p>125</p> <p>187</p> <p>250</p> <p>312</p> <p>375</p> <p>MAA45</p> <p>MAC45</p> <p>MAA90</p>	<p>3M1499</p> <p>3M1498</p> <p>3M1498</p> <p>3M1498</p> <p>3M1498</p> <p>3M1498</p> <p>3V678A</p> <p>3V678B</p> <p>3V678C</p>	<p>LxPxH (mm)</p> <p>465x280x35</p> <p>465x280x75</p> <p>620x280x35</p> <p>620x280x75</p> <p>P = 280</p>	<p>kit 93 step 93 kit</p> <p>kit 125 step 125 kit</p> <p>1 dx + 1 sx</p>
<p>PLATEAU PEINT 3NIV. PAINTED DISPLAY TRAY 3L</p> 	<p>93</p> <p>125</p> <p>187</p> <p>250</p> <p>312</p> <p>375</p> <p>MAA45</p> <p>MAC45</p> <p>MAA90</p>	<p>3M3149</p> <p>3M3148</p> <p>3M3148</p> <p>3M3148</p> <p>3M3148</p> <p>3M3148</p> <p>3V681A</p> <p>3V681B</p> <p>3V681C</p>	<p>LxPxH (mm)</p> <p>465x280x35</p> <p>465x280x75</p> <p>620x280x35</p> <p>620x280x75</p> <p>P = 280</p>	<p>kit 93 step 93 kit</p> <p>kit 125 step 125 kit</p> <p>1 dx + 1 sx</p>
<p>SEPARATION BASSE EN VERRE LOW GLASS DIVIDER</p> 	<p>TT</p>	<p>3V5507</p>	<p>PxH (mm)</p> <p>810x310</p>	
<p>mission: MKT</p>	<p>Code:QAP000101A</p>	<p>Rev.: 0</p>	<p>Date: 23.09.09</p>	<p>Chapitre/Chapter: 3</p>

PHOTO/DRAWING	USAGE/USE		Dimensions Dimensions	NOTES
	Long./Lenght	Code		
<p>SEPARATION BASSE EN VERRE H200 LOW GLASS DIVIDER H200</p> 	TT	3V4889	PxH (mm) 830x200	
<p>SEPAR. HAUTE VERRE LC HIGH GLASS DIVIDER LC</p> 	TT	3V4885	PxH (mm) 840x590	seul LC LC only
<p>SEPAR. HAUTE VERRE DC-LS HIGH GLASS DIVIDER DC-LS</p> 	TT	3V4886	PxH (mm) 910x590	seul DC-LS DC-LS only
<p>SEPAR. HAUTE VERRE LC-DC-LS 2L HIGH GLASS DIVIDER LC-DC-LS 2L</p> 	TT	3V4887	PxH (mm) 840x590	
<p>mission: MKT</p>	Code:QAP000101A	Rev.: 0	Date: 23.09.09	Chapitre/Chapter: 3

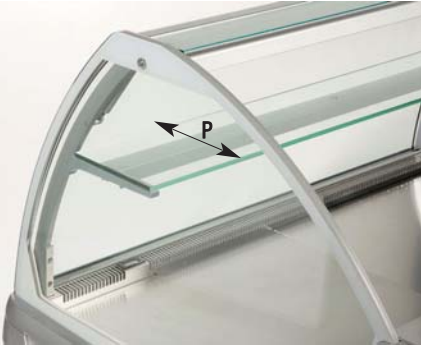
PHOTO/DRAWING	USAGE/USE		Dimensions Dimensions	NOTES
	Long./Lenght	Code		
<p>SEPAR. HAUTE VERRE LC-DC-LS 3L HIGH GLASS DIVIDER LC-DC-LS 3L</p> 	TT	3V4888	PxH (mm) 840x590	
<p>SEPARATION FIL PLASTIFIE LS WIRE DIVIDER LS</p> 	TT	blanche/white 3M1064 couleur/colou	PxH (mm) 790x195	seul LS LS only
<p>SEPARATION 2-3 NIV. FIL PLASTIFIE WIRE PAINTED DIVIDER 2-3 LEVELS</p> 	TT	blanche/white 3V5510 couleur/colou	PxH (mm) 710x195	
<p>RIDEAU DE NUIT LS NIGHT BLIND LS</p> 	93 125 187 250 312 375	3M0971 3M0972 3M0974 3M0976 3M0977 3M0978		seul LS LS only
mission: MKT	Code:QAP000101A	Rev.: 0	Date: 23.09.09	Chapitre/Chapter: 3

PHOTO/DRAWING	USAGE/USE		Dimensions Dimensions	NOTES
	Long./Lenght	Code		
TABLETTE INTERMEDIAIRE LC MIDDLE SHELF LC 	93 125 187 250 312 375	3V4391 3V4392 3V4394 3V4396 3V4397 3V4398	P = 235 mm	seul LC LC only
1/2 TABLETTE INTERMEDIAIRE LC SX 1/2 MIDDLE SHELF LC LEFT 	250 312 375	3V4400 3V4402 3V4404	P = 235 mm	seul LC RAC only
1/2 TABLETTE INTERMEDIAIRE LC DX 1/2 MIDDLE SHELF LC RIGHT 	250 312 375	3V4401 3V4403 3V4405	P = 235 mm	seul LC LC only
CLAYETTE DE CUVE LS PLASTICIZED BOTTOM GRILLES LS 	93 125 187 250 312 375 MAA45 MAC45 MAA90	3M1091 3M1092 3M1094 3M1096 3M1097 3M1098 3V554A 3V554B 3V554C	LxP (mm) 925x840 615x840 P = 840	seul LS LS only
.mission: MKT	Code:QAP000101A	Rev.: 0	Date: 23.09.09	Chapitre/Chapter: 3

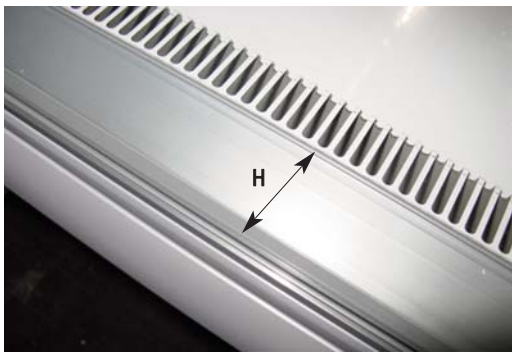
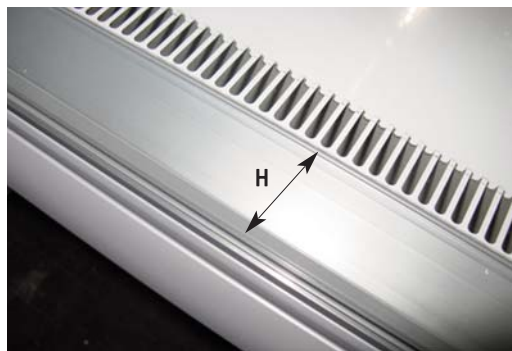
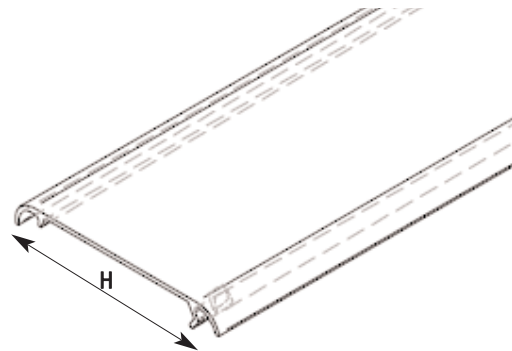
PHOTO/DRAWING	USAGE/USE		Dimensions Dimensions	NOTES
	Long./Lenght	Code		
<p>CLAYETTE DE CUVE COULEUR LS PAINTED BOTTOM GRILLES LS</p> 	<p>93 125 187 250 312 375</p> <p>MAA45 MAC45 MAA90</p>	<p>3M2191 3M2192 3M2194 3M2196 3M2197 3M2198</p> <p>3V555A 3V555B 3V555C</p>	<p>LxP (mm) 925x840 615x840 P = 840</p>	<p>seul LS LS only</p>
<p>PORTE AFFICHETTE LC TICKET HOLDER LC</p> 	<p>93 125 187 250 312 375</p>	<p>3V5571 3V5572 3V5574 3V5576 3V5577 3V5578</p>	<p>H = 40 mm</p>	<p>seul LC LC only</p>
<p>PORTE AFFICHETTE DC TICKET HOLDER DC</p> 	<p>93 125 187 250 312 375</p>	<p>3V5581 3V5582 3V5584 3V5586 3V5587 3V5588</p>	<p>H = 40 mm</p>	<p>seul DC DC only</p>
<p>COUVERTURE PORTE AFFICHETTE LC-DC-LS V.C. TICKET HOLDER COVER LC-DC-LS V.C.</p> 	<p>93 125</p>	<p>3V1831 3V1832</p>	<p>H = 52 mm</p>	
<p>mission: MKT</p>	<p>Code:QAP000101A</p>	<p>Rev.: 0</p>	<p>Date: 23.09.09</p>	<p>Chapitre/Chapter: 3</p>

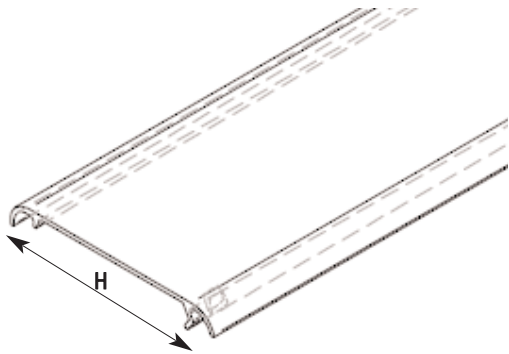
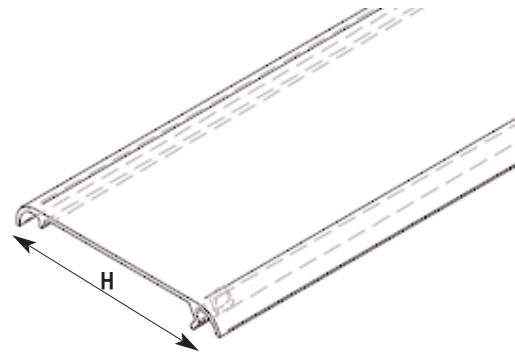
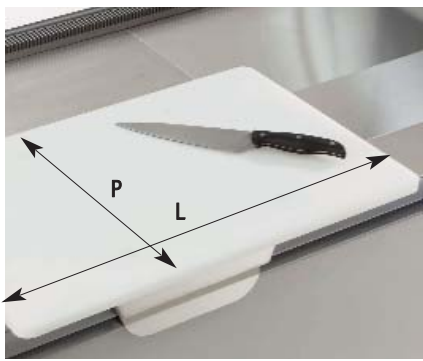
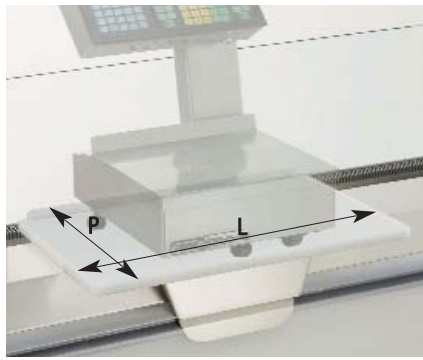
PHOTO/DRAWING	USAGE/USE		Dimensions Dimensions	NOTES
	Long./Lenght	Code		
<p>COUVERTURE PORTE AFFICHETTE LC V.C. TICKET HOLDER COVER LC V.C.</p> 	<p>187 250 312 375</p>	<p>3V1834 3V1836 3V1837 3V1838</p>	<p>H = 52 mm</p>	<p>seul LC LC only</p>
<p>COUVERTURE PORTE AFFICHETTE DC-LS V.C. TICKET HOLDER COVER LC-LS V.C.</p> 	<p>187 250 312 375</p>	<p>3V1824 3V1826 3V1827 3V1828</p>	<p>H = 52 mm</p>	<p>seul DC-LS DC-LS only</p>
<p>PLANCE A DECOUPER (ERGONOMIQUE) 170 mm CUTTING BOARD ERGONOMIC SHELF 170 mm</p> 	<p>TT</p>	<p>3V5560</p>	<p>LxP (mm) 595x395</p>	
<p>SUPPORT BALANCE (ERGONOMIQUE) 170 mm SCALE STAND ERGONOMIC SHELF 170 mm</p> 	<p>TT</p>	<p>3V5561</p>	<p>LxP (mm) 595x395</p>	
<p>mission: MKT</p>	<p>Code:QAP000101A</p>	<p>Rev.: 0</p>	<p>Date: 23.09.09</p>	<p>Chapitre/Chapter: 3</p>

PHOTO/DRAWING	USAGE/USE		Dimensions Dimensions	NOTES
	Long./Lenght	Code		
<p>PLANCE A DECOUPER TABLETTE AR. 210 mm CUTTING BOARD SHELF 170 mm</p> 	TT	3V5562	LxP (mm) 595x395	
<p>SUPPORT BALANCE TABLETTE AR. 210 mm SCALE STAND SHELF 210 mm</p> 	TT	3V5563	LxP (mm) 595x395	
<p>SUPPORT BALANCE TABLETTE AR. 300 mm SCALE STAND SHELF 300 mm</p> 	TT	3V5564	LxP (mm) 595x395	
<p>RENDEUR BILLETS (VITRAGE DC) TICHET DISH (DC)</p> 	TT	3V5504	LxP (mm) 300x220	seul DC DC only
<p>mission: MKT</p>	Code:QAP000101A	Rev.: 0	Date: 23.09.09	Chapitre/Chapter: 3

MAXIMA MODULAR

PHOTO/DRAWING	USAGE/USE		Dimensions Dimensions	NOTES
	Long./Lenght	Code		
<p>SUPPORT MONNAIE (VITRAGE DC) CHANGE DISH (DC)</p> 	TT	3V5505	LxP (mm) 300x200	seul DC DC only
<p>PORTE-COUTEAUX KNIFE HOLDER</p> 	TT	3V5568	LxPxH (mm) 410x150X410	
<p>PORTE-COUTEAUX TABLETTE AR. 300 KNIFE HOLDER REAR SHELF 300</p> 	TT	M0013200	LxPxH (mm) 410x150X410	
<p>SUPPORT PAPIER PAPER HOLDER</p> 	TT	3V5569	LxPxH (mm) 565x100X370	
.mission: MKT	Code:QAP000101A	Rev.: 0	Date: 23.09.09	Chapitre/Chapter: 3

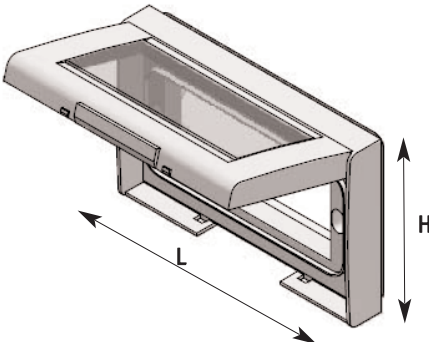
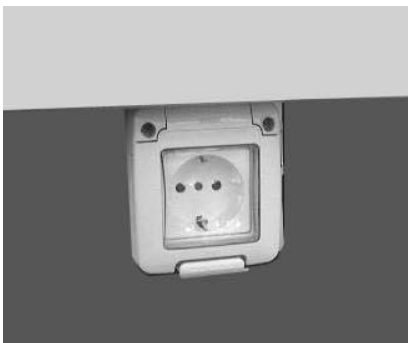
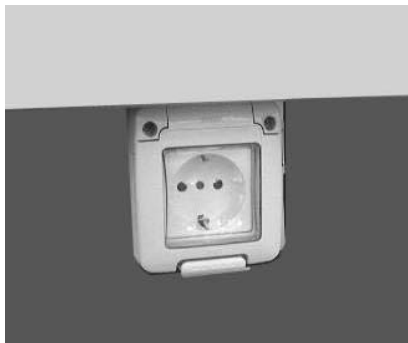
PHOTO/DRAWING	USAGE/USE		Dimensions Dimensions	NOTES
	Long./Lenght	Code		
<p>PORTE ROULEAUX ROLL HOLDER</p> 	TT	3V5593	LxPxH (mm) 400x160X180	
<p>PROTECTION INTERRUPTEURS IP55 IP55 SWITCH PROTECTION</p> 	93 125 187 250 312 375 MAA45 MAC45 MAA90	3M3729 M0024700 3M3729 M0024700	LxH (mm) 140x90	
<p>KIT PRISE SOCKET KIT</p> 	125 187 250 312 375 187 250 312 375	3V5282 3V5283	kit 1 prise 1 socket kit kit 2 prises 2 sockets kit	
<p>KIT PRISE FRANCE FRANCE SOCKET KIT</p> 	125 187 250 312 375 187 250 312 375	3V5284 3V5285	kit 1 prise 1 socket kit kit 2 prises 2 sockets kit	seul pour France for France only
.mission: MKT	Code:QAP000101A	Rev.: 0	Date: 23.09.09	Chapitre/Chapter: 3

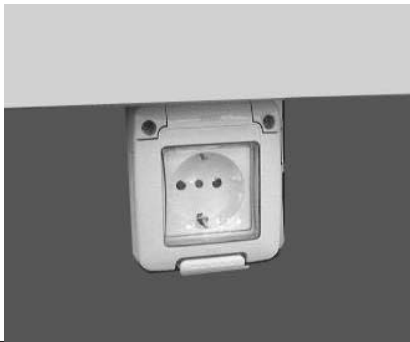
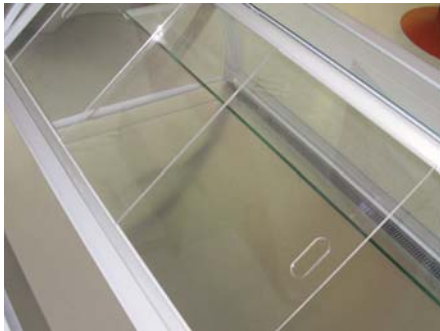
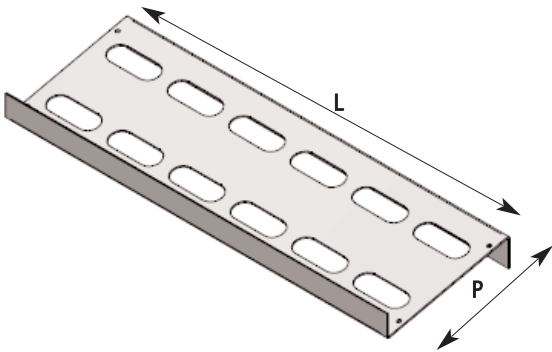
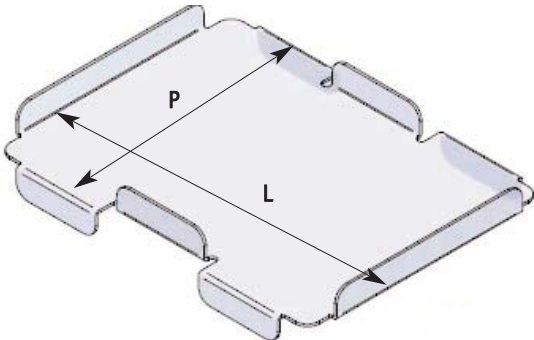

PHOTO/DRAWING	USAGE/USE		Dimensions Dimensions	NOTES
	Long./Lenght	Code		
KIT PRISE UK UK SOCKET KIT 	125 187 250 312 375 187 250 312 375	3V5286 3V5287	kit 1 prise 1 socket kit kit 2 prises 2 sockets kit	seul pour UK for UK only
PANNEAUX ARRIERES COULISSANTS REAR SLIDERS 	93 125 187 250 318 375 MAA45 MAC45 MAA90	3V4461 3V4462 3V4464 3V4466 3V4467 3V4468 3V446A 3V446B 3V446C		
KIT HAUSSE PRODUIT RISE PRODUCT KIT 	125 187 250 318 375 MAA45	3V5518	LxP (mm) 260x225	
KIT SUPPORT PAPIER (40X27 TABLETTE AR. 300 mm) PAPER HOLDER (40X27 REAR SHELF 300 mm) 	93 125 187 250 318 375 MAA45 MAA90	3V5519	LxP (mm) 460x360	
.mission: MKT	Code:QAP000101A	Rev.: 0	Date: 23.09.09	Chapitre/Chapter: 3



MAXIMA MODULAR

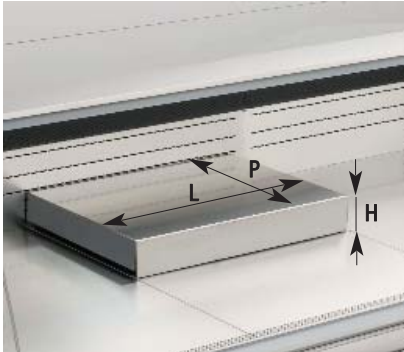

PHOTO/DRAWING	USAGE/USE		Dimensions Dimensions	NOTES
	Long./Lenght	Code		
PARE-CHOCS INOX ST. STEEL BUMPER RAIL 	93 125 187 250 312 375 MAA45 MAC45 MAA90	3M2271 3M2272 3M2274 3M2276 3M2277 3M2278 3V506A 3V506B 3V506C		
.mission: MKT	Code:QAP000101A	Rev.: 0	Date: 23.09.09	Chapitre/Chapter: 3

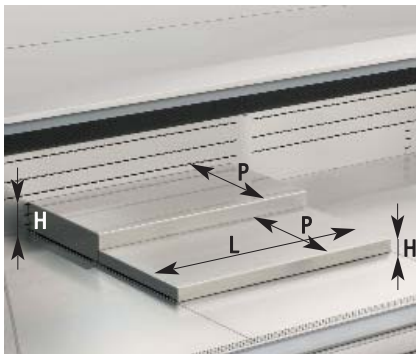
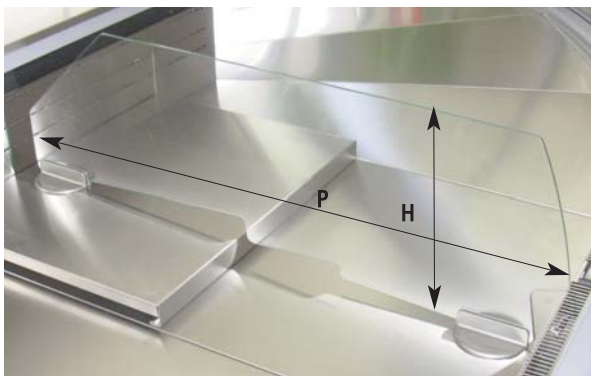
PHOTO/DRAWING	USAGE/USE		Dimensions Dimensions	NOTES
	Long./Lenght	Code		
PROFIL PORTE-ACCESSOIRES (obligatoire pour LC e RBC) ACCESSORIES RAIL (compulsory for LC and DC) 	93 125 187 250 312 375 MAA45 MAC45 MAA90	3V5131 3V5132 3V5134 3V5136 3V5137 3V5138 3V513A 3V513B 3V513C		
PLATEAU INOX 2NIV. H40 ST. STEEL DISPLAY TRAY 2L H40 	93 125 187 250 312 375 MAA45 MAC45 MAA90	3M1479 3M1478 3M1478 3M1478 3M1478 3M1478 3V676A 3V676B 3V676C	LxPxH (mm) 465x420x40 620x420x40 P = 420	kit 93 step 93 kit kit 125 step 125 kit 1 dx + 1 sx
PLATEAU PEINT 2NIV. H40 PAINTED DISPLAY TRAY 2L H40 	93 125 187 250 312 375 MAA45 MAC45 MAA90	3M3129 3M3128 3M3128 3M3128 3M3128 3M3128 3V679A 3V679B 3V679C	LxPxH (mm) 465x420x40 620x420x40 P = 420	kit 93 step 93 kit kit 125 step 125 kit 1 dx + 1 sx
PLATEAU INOX 2NIV. H90 ST. STEEL DISPLAY TRAY 2L H90 	93 125 187 250 312 375 MAA45 MAC45 MAA90	3M1489 3M1488 3M1488 3M1488 3M1488 3M1488 3V677A 3V677B 3V677C	LxPxH (mm) 465x420x40 620x420x40 P = 420	kit 93 step 93 kit kit 125 step 125 kit 1 dx + 1 sx
.mission: MKT	Code:QAP000101A	Rev.: 0	Date: 23.09.09	Chapitre/Chapter: 4

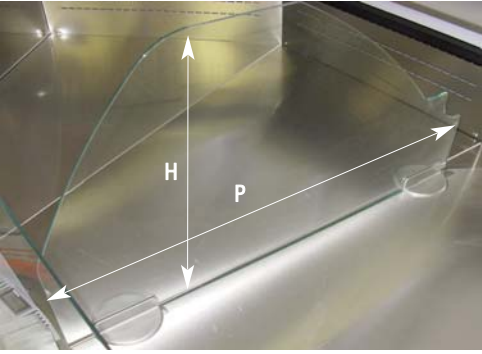
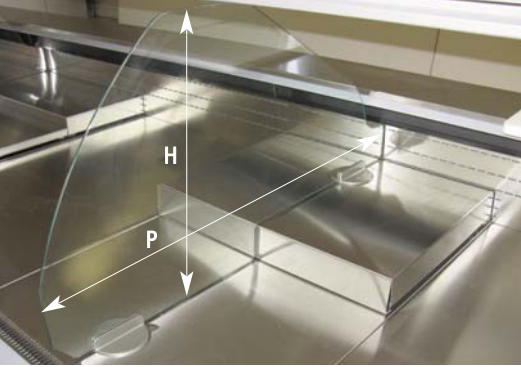
MAXIMA MODULAR PREMIUM

PHOTO/DRAWING	USAGE/USE		Dimensions Dimensions	NOTES
	Long./Lenght	Code		
<p>PLATEAU PEINT 2NIV. H90 PAINTED DISPLAY TRAY 2L H90</p> 	<p>93</p> <p>125</p> <p>187</p> <p>250</p> <p>312</p> <p>375</p> <p>MAA45</p> <p>MAC45</p> <p>MAA90</p>	<p>3M3139</p> <p>3M3138</p> <p>3M3138</p> <p>3M3138</p> <p>3M3138</p> <p>3M3138</p> <p>3M3138</p> <p>3V690A</p> <p>3V680B</p> <p>3V680C</p>	<p>LxPxH (mm)</p> <p>465x420x40</p> <p>620x420x40</p> <p>P = 420</p>	<p>kit 93 step 93 kit</p> <p>kit 125 step 125 kit</p> <p>1 dx + 1 sx</p>
<p>PLATEAU INOX 3NIV. ST. STEEL DISPLAY TRAY 3L</p> 	<p>93</p> <p>125</p> <p>187</p> <p>250</p> <p>312</p> <p>375</p> <p>MAA45</p> <p>MAC45</p> <p>MAA90</p>	<p>3M1499</p> <p>3M1498</p> <p>3M1498</p> <p>3M1498</p> <p>3M1498</p> <p>3M1498</p> <p>3M1498</p> <p>3V678A</p> <p>3V678B</p> <p>3V678C</p>	<p>LxPxH (mm)</p> <p>465x280x35</p> <p>465x280x75</p> <p>620x280x35</p> <p>620x280x75</p> <p>P = 280</p>	<p>kit 93 step 93 kit</p> <p>kit 125 step 125 kit</p> <p>1 dx + 1 sx</p>
<p>PLATEAU PEINT 3NIV. PAINTED DISPLAY TRAY 3L</p> 	<p>93</p> <p>125</p> <p>187</p> <p>250</p> <p>312</p> <p>375</p> <p>MAA45</p> <p>MAC45</p> <p>MAA90</p>	<p>3M3149</p> <p>3M3148</p> <p>3M3148</p> <p>3M3148</p> <p>3M3148</p> <p>3M3148</p> <p>3M3148</p> <p>3V681A</p> <p>3V681B</p> <p>3V681C</p>	<p>LxPxH (mm)</p> <p>465x280x35</p> <p>465x280x75</p> <p>620x280x35</p> <p>620x280x75</p> <p>P = 280</p>	<p>kit 93 step 93 kit</p> <p>kit 125 step 125 kit</p> <p>1 dx + 1 sx</p>
<p>SEPARATION BASSE EN VERRE LOW GLASS DIVIDER</p> 	<p>TT</p>	<p>3V5507</p>	<p>PxH (mm)</p> <p>810x310</p>	
<p>mission: MKT</p>	<p>Code:QAP000101A</p>	<p>Rev.: 0</p>	<p>Date: 23.09.09</p>	<p>Chapitre/Chapter: 4</p>

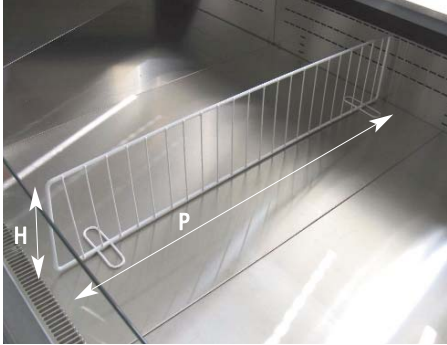
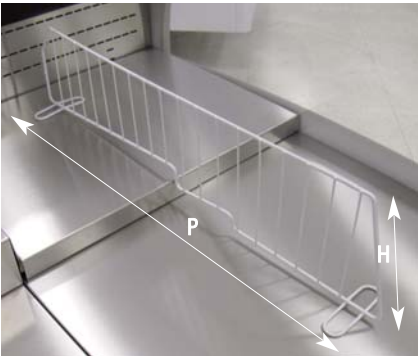
PHOTO/DRAWING	USAGE/USE		Dimensions Dimensions	NOTES
	Long./Lenght	Code		
<p>SEPARATION BASSE EN VERRE H200 LOW GLASS DIVIDER H200</p> 	TT	3V4889	PxH (mm) 830x200	
<p>SEPAR. HAUTE VERRE DC-LS HIGH GLASS DIVIDER DC-LS</p> 	TT	3V4886	PxH (mm) 910x590	seul DC-LS DC-LS only
<p>SEPAR. HAUTE VERRE DC-LS 2L HIGH GLASS DIVIDER DC-LS 2L</p> 	TT	3V4887	PxH (mm) 840x590	
<p>SEPAR. HAUTE VERRE LC-DC-LS 3L HIGH GLASS DIVIDER LC-DC-LS 3L</p> 	TT	3V4888	PxH (mm) 840x590	
<p>mission: MKT</p>	Code:QAP000101A	Rev.: 0	Date: 23.09.09	Chapitre/Chapter: 3

PHOTO/DRAWING	USAGE/USE		Dimensions Dimensions	NOTES
	Long./Lenght	Code		
<p>SEPARATION FIL PLASTIFIE LS WIRE DIVIDER LS</p> 	TT	blanche/white 3M1064 couleur/colou	PxH (mm) 790x195	seul LS LS only
<p>SEPARATION 2-3 NIV. FIL PLASTIFIE WIRE PAINTED DIVIDER 2-3 LEVELS</p> 	TT	blanche/white 3V5510 couleur/colou	PxH (mm) 710x195	
<p>RIDEAU DE NUIT LS NIGHT BLIND LS</p> 	93 125 187 250 312 375	3M0971 3M0972 3M0974 3M0976 3M0977 3M0978		seul LS LS only
<p>CLAYETTE DE CUVE LS PLASTICIZED BOTTOM GRILLES LS</p> 	93 125 187 250 312 375 MAA45 MAC45 MAA90	3M1091 3M1092 3M1094 3M1096 3M1097 3M1098 3V554A 3V554B 3V554C	LxP (mm) 925x840 615x840 P = 840	seul LS LS only
.mission: MKT	Code:QAP000101A	Rev.: 0	Date: 23.09.09	Chapitre/Chapter: 4

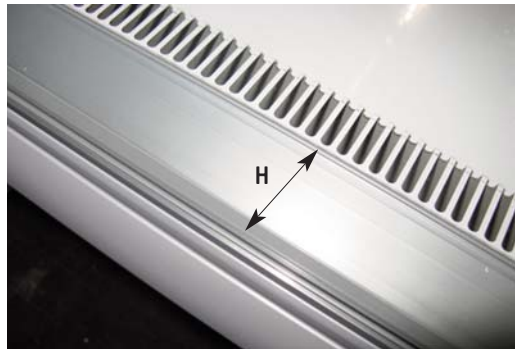
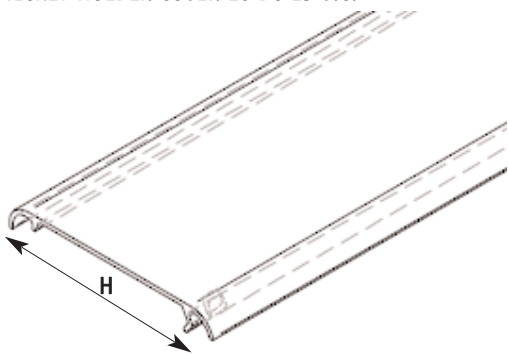
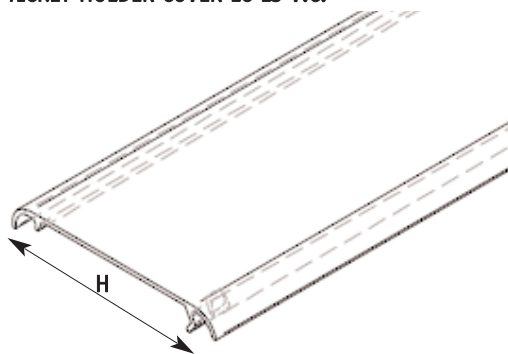

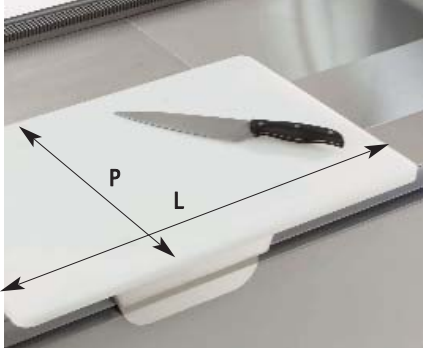
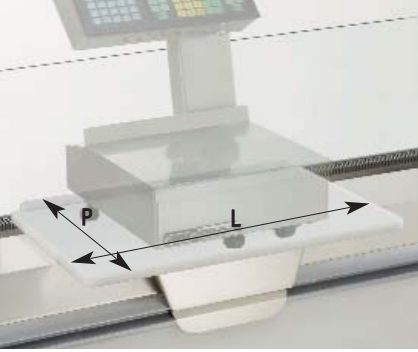
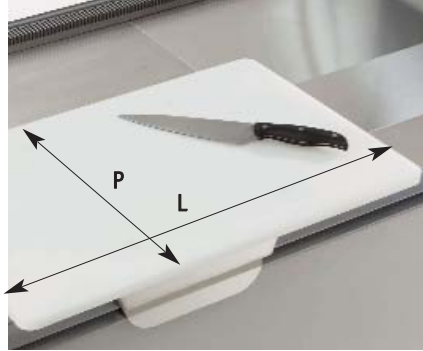
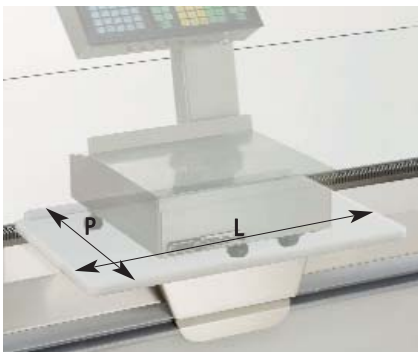



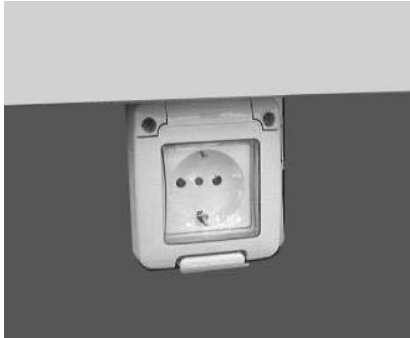

PHOTO/DRAWING	USAGE/USE		Dimensions Dimensions	NOTES
	Long./Lenght	Code		
<p>CLAYETTE DE CUVE COULEUR LS PAINTED BOTTOM GRILLES LS</p> 	<p>93 125 187 250 312 375</p> <p>MAA45 MAC45 MAA90</p>	<p>3M2191 3M2192 3M2194 3M2196 3M2197 3M2198</p> <p>3V555A 3V555B 3V555C</p>	<p>LxP (mm)</p> <p>925x840</p> <p>615x840</p> <p>P = 840</p>	<p>seul LS LS only</p>
<p>PORTE AFFICHETTE DC TICKET HOLDER DC</p> 	<p>93 125 187 250 312 375</p>	<p>3V5581 3V5582 3V5584 3V5586 3V5587 3V5588</p>	<p>H = 40 mm</p>	
<p>COUVERTURE PORTE AFFICHETTE LC-DC-LS V.C. TICKET HOLDER COVER LC-DC-LS V.C.</p> 	<p>93 125</p>	<p>3V1831 3V1832</p>	<p>H = 52 mm</p>	
<p>COUVERTURE PORTE AFFICHETTE DC-LS V.C. TICKET HOLDER COVER LC-LS V.C.</p> 	<p>187 250 312 375</p>	<p>3V1824 3V1826 3V1827 3V1828</p>	<p>H = 52 mm</p>	
<p>mission: MKT</p>	<p>Code:QAP000101A</p>	<p>Rev.: 0</p>	<p>Date: 23.09.09</p>	<p>Chapitre/Chapter: 4</p>

PHOTO/DRAWING	USAGE/USE		Dimensions Dimensions	NOTES
	Long./Lenght	Code		
<p>PLANCE A DECOUPER (ERGONOMIQUE) 170 mm CUTTING BOARD ERGONOMIC SHELF 170 mm</p> 	TT	3V5560	LxP (mm) 595x395	
<p>SUPPORT BALANCE (ERGONOMIQUE) 170 mm SCALE STAND ERGONOMIC SHELF 170 mm</p> 	TT	3V5561	LxP (mm) 595x395	
<p>PLANCE A DECOUPER TABLETTE AR. 210 mm CUTTING BOARD SHELF 170 mm</p> 	TT	3V5562	LxP (mm) 595x395	
<p>SUPPORT BALANCE TABLETTE AR. 210 mm SCALE STAND SHELF 210 mm</p> 	TT	3V5563	LxP (mm) 595x395	
<p>mission: MKT</p>	Code:QAP000101A	Rev.: 0	Date: 23.09.09	Chapitre/Chapter: 4

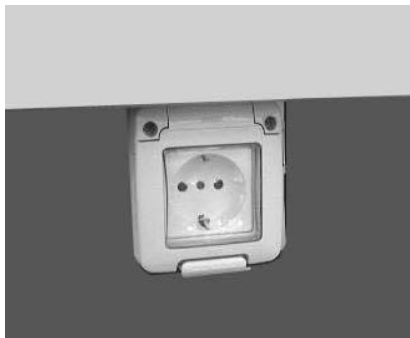
PHOTO/DRAWING	USAGE/USE		Dimensions Dimensions	NOTES
	Long./Lenght	Code		
<p>SUPPORT BALANCE TABLETTE AR. 300 mm SCALE STAND SHELF 300 mm</p> 	TT	3V5564	LxP (mm) 595x395	
<p>RENDEUR BILLETS (VITRAGE DC) TICHET DISH (DC)</p> 	TT	3V5504	LxP (mm) 300x220	seul DC DC only
<p>SUPPORT MONNAIE (VITRAGE DC) CHANGE DISH (DC)</p> 	TT	3V5505	LxP (mm) 300x200	seul DC DC only
<p>PORTE-COUTEAUX KNIFE HOLDER</p> 	TT	3V5568	LxPxH (mm) 410x150x410	
.mission: MKT	Code:QAP000101A	Rev.: 0	Date: 23.09.09	Chapitre/Chapter: 4

PHOTO/DRAWING	USAGE/USE		Dimensions Dimensions	NOTES
	Long./Lenght	Code		
<p>PORTE-COUTEAUX TABLETTE AR. 300 KNIFE HOLDER REAR SHELF 300</p> 	TT	M0013200	LxPxH (mm) 410x150X410	
<p>SUPPORT PAPIER PAPER HOLDER</p> 	TT	3V5569	LxPxH (mm) 565x100X370	
<p>PORTE ROULEAUX ROLL HOLDER</p> 	TT	3V5593	LxPxH (mm) 400x160X180	
<p>PROTECTION INTERRUPTEURS IP55 IP55 SWITCH PROTECTION</p> 	<p>93 125 187 250 312 375</p> <p>MAA45 MAC45 MAA90</p>	<p>3M3729</p> <p>M0024700 3M3729 M0024700</p>	LxH (mm) 140x90	
<p>mission: MKT</p>	Code:QAP000101A	Rev.: 0	Date: 23.09.09	Chapitre/Chapter: 4

MAXIMA MODULAR PREMIUM

PHOTO/DRAWING	USAGE/USE		Dimensions Dimensions	NOTES
	Long./Lenght	Code		
KIT PRISE SOCKET KIT 	125	3V5282	kit 1 prise 1 socket kit	
	187			
250				
312				
375				
	187	3V5283	kit 2 prises 2 sockets kit	
	250			
312				
375				
KIT PRISE FRANCE FRANCE SOCKET KIT 	125			
	187			
250				
312				
375				
	187	3V5285	kit 2 prises 2 sockets kit	
	250			
312				
375				
KIT PRISE UK UK SOCKET KIT 	125			
	187			
250				
312				
375				
	187	3V5287	kit 2 prises 2 sockets kit	
	250			
312				
375				
PARE-CHOCS INOX ST. STEEL BUMPER RAIL 	93			
	125	3M2272		
	187	3M2274		
	250	3M2276		
	312	3M2277		
	375	3M2278		
	MAA45	3V506A		
	MAC45	3V506B		
MAA90	3V506C			

PHOTO/DRAWING	USAGE/USE		Dimensions Dimensions	NOTES
	Long./Lenght	Code		
PROFIL PORTE-ACCESSOIRES (obligatoire pour LC e RBC) ACCESSORIES RAIL (compulsory for LC and DC) 	125 187 250 312 375 MAA45 MAC45 MAA90	3V5122 3V5124 3V5126 3V5127 3V5128 3V512A 3V512B 3V512C		
PLATEAU INOX 2NIV. H40 ST. STEEL DISPLAY TRAY 2L H40 	125 187 250 312 375 MAA45 MAC45 MAA90	3M1478 3M1478 3M1478 3M1478 3M1478 3V676A 3V676B 3V676C	LxPxH (mm) 620x420x40 P = 420	kit 125 step 125 kit 1 dx + 1 sx
PLATEAU PEINT 2NIV. H40 PAINTED DISPLAY TRAY 2L H40 	125 187 250 312 375 MAA45 MAC45 MAA90	3M3128 3M3128 3M3128 3M3128 3M3128 3V679A 3V679B 3V679C	LxPxH (mm) 620x420x40 P = 420	kit 125 step 125 kit 1 dx + 1 sx
SEPARATION BASSE EN VERRE LOW GLASS DIVIDER 	TT	3V5507	PxH (mm) 810x310	
.mission: MKT	Code:QAP000101A	Rev.: 0	Date: 23.09.09	Chapitre/Chapter: 5

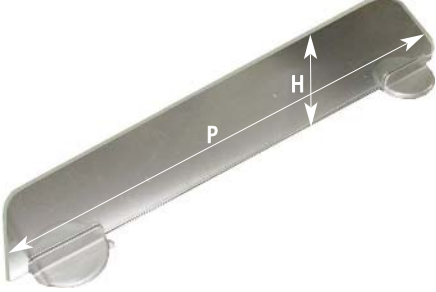
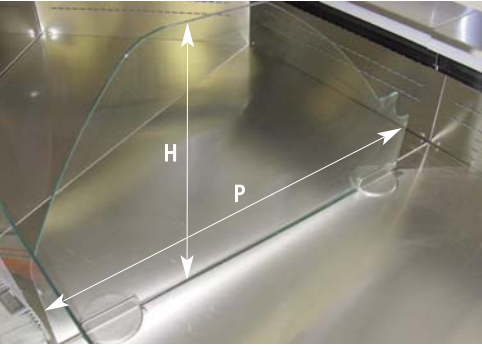
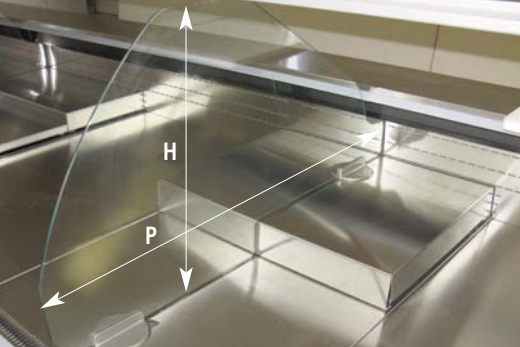
PHOTO/DRAWING	USAGE/USE		Dimensions Dimensions	NOTES
	Long./Lenght	Code		
<p>SEPARATION BASSE EN VERRE H200 LOW GLASS DIVIDER H200</p> 	TT	3V4889	PxH (mm) 830x200	
<p>SEPAR. HAUTE VERRE LC HIGH GLASS DIVIDER LC</p> 	TT	3V4885	PxH (mm) 840x590	seul LC LC only
<p>SEPAR. HAUTE VERRE DC-LS HIGH GLASS DIVIDER DC-LS</p> 	TT	3V4886	PxH (mm) 910x590	seul DC-LS DC-LS only
<p>SEPAR. HAUTE VERRE LC-DC-LS 2L HIGH GLASS DIVIDER LC-DC-LS 2L</p> 	TT	3V4887	PxH (mm) 840x590	
<p>mission: MKT</p>	Code:QAP000101A	Rev.: 0	Date: 23.09.09	Chapitre/Chapter: 5

PHOTO/DRAWING	USAGE/USE		Dimensions Dimensions	NOTES
	Long./Lenght	Code		
<p>SEPAR. HAUTE VERRE LC-DC-LS 3L HIGH GLASS DIVIDER LC-DC-LS 3L</p> 	TT	3V4888	PxH (mm) 840x590	
<p>SEPAR. HAUTE VERRE DC2L HIGH GLASS DIVIDER DC 2L</p> 	TT	3M3769	PxH (mm) 840x590	
<p>PORTE AFFICHETTE LC TICKET HOLDER LC</p> 	125 187 250 312 375	3V5572 3V5574 3V5576 3V5577 3V5578	H = 40 mm	seul LC LC only
<p>PORTE AFFICHETTE DC TICKET HOLDER DC</p> 	125 187 250 312 375	3V5582 3V5584 3V5586 3V5587 3V5588	H = 40 mm	seul DC DC only
mission: MKT	Code:QAP000101A	Rev.: 0	Date: 23.09.09	Chapitre/Chapter: 5

CANOVA PERFORM

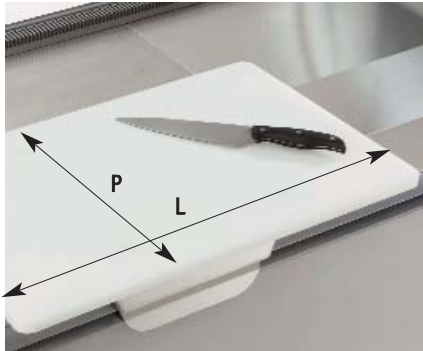
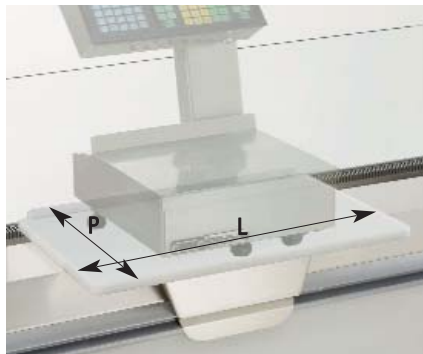
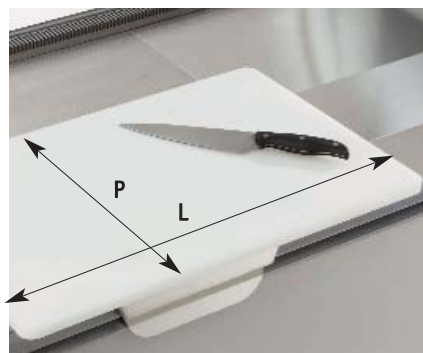
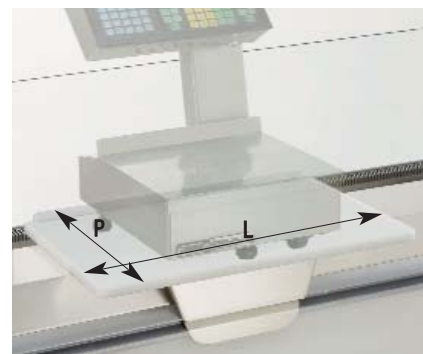

PHOTO/DRAWING	USAGE/USE		Dimensions Dimensions	NOTES
	Long./Lenght	Code		
<p>PLANCE A DECOUPER (ERGONOMIQUE) 170 mm CUTTING BOARD ERGONOMIC SHELF 170 mm</p> 	TT	3V5560	LxP (mm) 595x395	
<p>SUPPORT BALANCE (ERGONOMIQUE) 170 mm SCALE STAND ERGONOMIC SHELF 170 mm</p> 	TT	3V5561	LxP (mm) 595x395	
<p>PLANCE A DECOUPER TABLETTE AR. 210 mm CUTTING BOARD SHELF 170 mm</p> 	TT	3V5562	LxP (mm) 595x395	
<p>SUPPORT BALANCE TABLETTE AR. 210 mm SCALE STAND SHELF 210 mm</p> 	TT	3V5563	LxP (mm) 595x395	
<p>mission: MKT</p>	Code:QAP000101A	Rev.: 0	Date: 23.09.09	Chapitre/Chapter: 5

PHOTO/DRAWING	USAGE/USE		Dimensions Dimensions	NOTES
	Long./Lenght	Code		
SUPPORT BALANCE TABLETTE AR. 300 mm SCALE STAND SHELF 300 mm 	TT	3V5564	LxP (mm) 595x395	
RENDEUR BILLETS (VITRAGE DC) TICHET DISH (DC) 	TT	3V5504	LxP (mm) 300x220	seul DC DC only
SUPPORT MONNAIE (VITRAGE DC) CHANGE DISH (DC) 	TT	3V5505	LxP (mm) 300x200	seul DC DC only
PORTE-COUTEAUX KNIFE HOLDER 	TT	3V5568	LxPxH (mm) 410x150x410	
mission: MKT	Code:QAP000101A	Rev.: 0	Date: 23.09.09	Chapitre/Chapter:

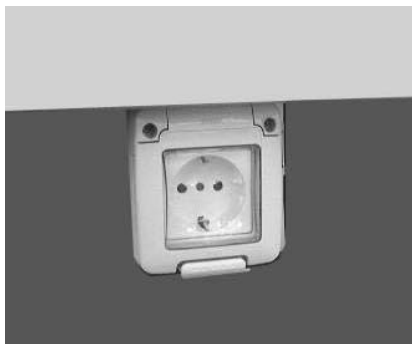
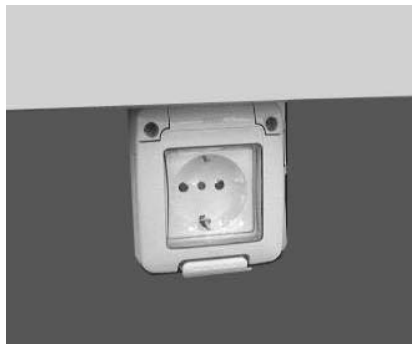
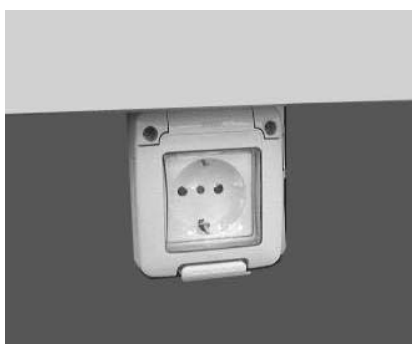
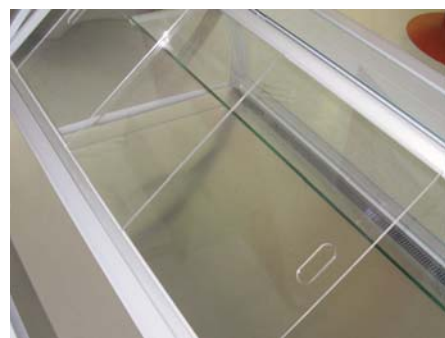

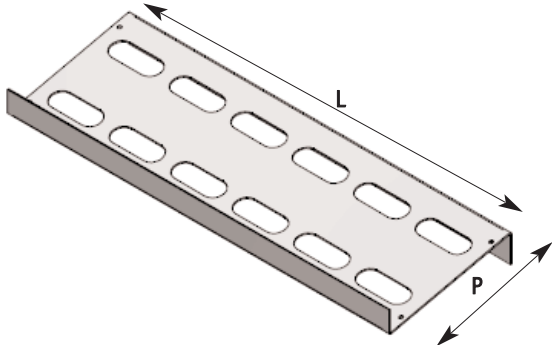
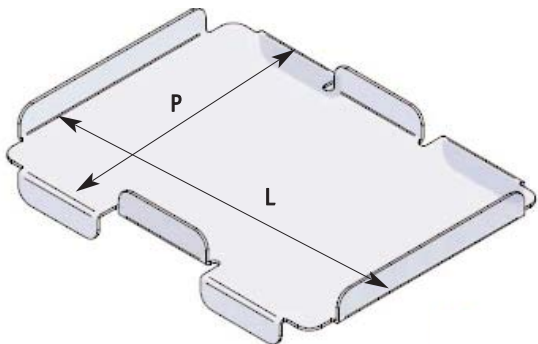
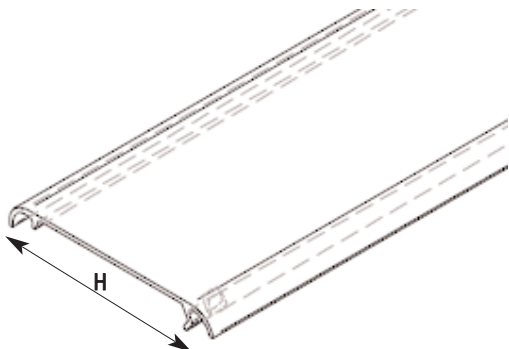
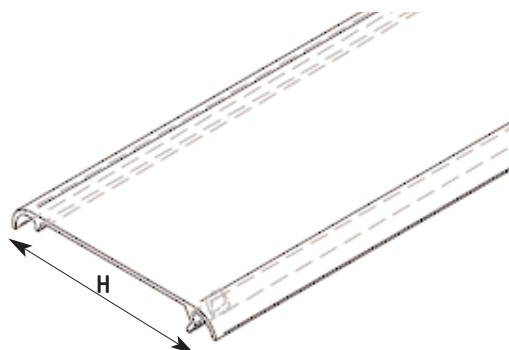

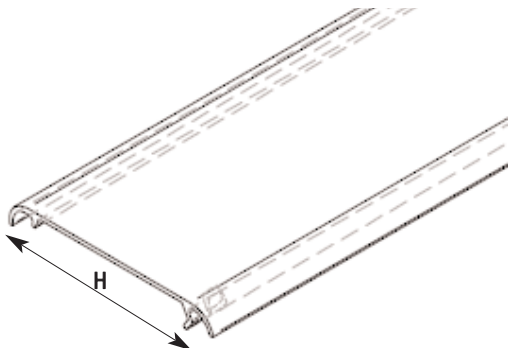
PHOTO/DRAWING	USAGE/USE		Dimensions Dimensions	NOTES
	Long./Lenght	Code		
<p>PORTE-COUTEAUX TABLETTE AR. 300 KNIFE HOLDER REAR SHELF 300</p> 	TT	M0013200	LxPxH (mm) 410x150X410	
<p>SUPPORT PAPIER PAPER HOLDER</p> 	TT	3V5569	LxPxH (mm) 565x100X370	
<p>PORTE ROULEAUX ROLL HOLDER</p> 	TT	3V5593	LxPxH (mm) 400x160X180	
<p>PROTECTION INTERRUPTEURS IP55 IP55 SWITCH PROTECTION</p> 	TT	3M3729	LxH (mm) 140x90	
<p>mission: MKT</p>	Code:QAP000101A	Rev.: 0	Date: 23.09.09	Chapitre/Chapter: 5

PHOTO/DRAWING	USAGE/USE		Dimensions Dimensions	NOTES
	Long./Lenght	Code		
KIT PRISE SOCKET KIT 	125 187 250 312 375 187 250 312 375	3V5282 3V5283	kit 1 prise 1 socket kit kit 2 prises 2 sockets kit	
KIT PRISE FRANCE FRANCE SOCKET KIT 	125 187 250 312 375 187 250 312 375	3V5284 3V5285	kit 1 prise 1 socket kit kit 2 prises 2 sockets kit	seul pour France for France only
KIT PRISE UK UK SOCKET KIT 	125 187 250 312 375 187 250 312 375	3V5286 3V5287	kit 1 prise 1 socket kit kit 2 prises 2 sockets kit	seul pour UK for UK only
PANNEAUX ARRIERES COULISSANTS REAR SLIDERS 	93 125 187 250 318 375 MAA45 MAC45 MAA90	3V4461 3V4462 3V4464 3V4466 3V4467 3V4468 3V446A 3V446B 3V446C		
.mission: MKT	Code:QAP000101A	Rev.: 0	Date: 23.09.09	Chapitre/Chapter: 3



PHOTO/DRAWING	USAGE/USE		Dimensions Dimensions	NOTES
	Long./Lenght	Code		
<p>KIT HAUSSE PRODUIT RISE PRODUCT KIT</p> 	<p>125 187 250 318 375 MAA45</p>	<p>3V5518</p>	<p>LxP (mm) 260x225</p>	
<p>KIT SUPPORT PAPIER (40X27 TABLETTE AR. 300 mm) PAPER HOLDER (40X27 REAR SHELF 300 mm)</p> 	<p>93 125 187 250 318 375 MAA45 MAA90</p>	<p>3V5519</p>	<p>LxP (mm) 460x360</p>	
<p>COUVERTURE PORTE AFFICHETTE LC-DC-LS V.C. TICKET HOLDER COVER LC-DC-LS V.C.</p> 	<p>125</p>	<p>3V1832</p>	<p>H = 52 mm</p>	
<p>COUVERTURE PORTE AFFICHETTE LC V.C. TICKET HOLDER COVER LC V.C.</p> 	<p>187 250 312 375</p>	<p>3V1834 3V1836 3V1837 3V1838</p>	<p>H = 52 mm</p>	<p>seul LC LC only</p>
<p>mission: MKT</p>	<p>Code:QAP000101A</p>	<p>Rev.: 0</p>	<p>Date: 23.09.09</p>	<p>Chapitre/Chapter: 3</p>

PHOTO/DRAWING	USAGE/USE		Dimensions Dimensions	NOTES
	Long./Lenght	Code		
COUVERTURE PORTE AFFICHETTE DC-LS V.C. TICKET HOLDER COVER LC-LS V.C. 	187 250 312 375	3V1824 3V1826 3V1827 3V1828	H = 52 mm	seul DC-LS DC-LS only
PARE-CHOC INOX ST. STEEL BUMPER RAIL 	125 187 250 312 375 MAA45 MAC45 MAA90	3M2272 3M2274 3M2276 3M2277 3M2278 3V506A 3V506B 3V506C		
.mission: MKT	Code:QAP000101A	Rev.: 0	Date: 23.09.09	Chapitre/Chapter: 5

MAXIMA MODULAR PS (pastry)

PHOTO/DRAWING	USAGE/USE		Dimensions Dimensions	NOTES
	Long./Lenght	Code		
TABLETTE INTERMEDIAIRE 280 LC MIDDLE SHELF 280 LC 	125 250	3V6182 3V6186	P = 280 mm	
TABLETTE INTERMEDIAIRE 280 LC COULEUR COLOR MIDDLE SHELF 280 LC 	125 250	3V6192 3V6196	P = 280 mm	
TABLETTE INTERMEDIAIRE LC MIDDLE SHELF LC 	125 250	3V4392 3V4396	P = 235 mm	
1/2 TABLETTE INTERMEDIAIRE LC 1/2 MIDDLE SHELF LC 	250 375	3V4400 3V4401	P = 235 mm	
.mission: MKT	Code:QAP000101A	Rev.: 0	Date: 23.09.09	Chapitre/Chapter: 6

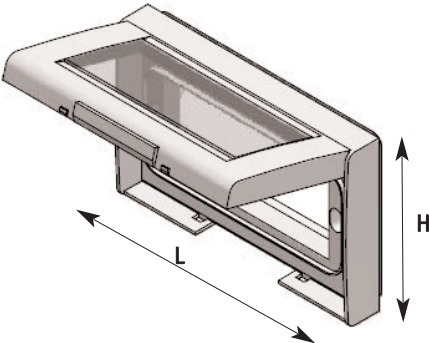
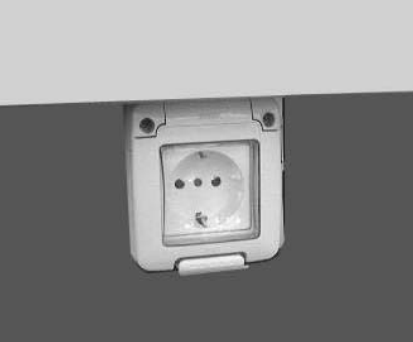
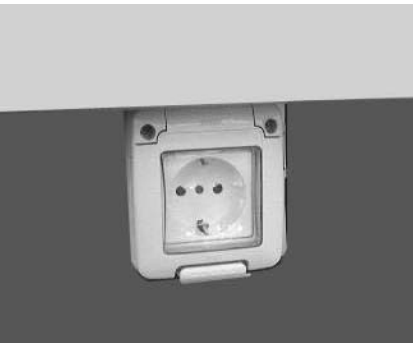

PHOTO/DRAWING	USAGE/USE		Dimensions Dimensions	NOTES
	Long./Lenght	Code		
<p>PANNEAUX ARRIERES COULISSANTS REAR SLIDERS</p> 	125 250	3V4462 3V4466		
<p>PORTE AFFICHETTE LC TICKET HOLDER LC</p> 	125 250	3V5572 3V5576	H = 40 mm	
<p>COUVERTURE PORTE AFFICHETTE LC-DC-LS V.C. TICKET HOLDER COVER LC-DC-LS V.C.</p> 	125	3V1832	H = 52 mm	
<p>COUVERTURE PORTE AFFICHETTE LC-DC-LS V.C. TICKET HOLDER COVER LC-DC-LS V.C.</p> 	250	3V1836	H = 52 mm	
<p>mission: MKT</p>	Code:QAP000101A	Rev.: 0	Date: 23.09.09	Chapitre/Chapter: 6

PHOTO/DRAWING	USAGE/USE		Dimensions Dimensions	NOTES
	Long./Lenght	Code		
<p>PROTECTION INTERRUPTEURS IP55 IP55 SWITCH PROTECTION</p> 	125 250	3M3729	LxH (mm) 140x90	
<p>KIT PRISE SOCKET KIT</p> 	125 250	3V5282	kit 1 prise 1 socket kit	
<p>KIT PRISE FRANCE FRANCE SOCKET KIT</p> 	125 250	3V5284	kit 1 prise 1 socket kit	seul pour France for France only
	125 250	3V5285	kit 2 prises 2 sockets kit	
<p>KIT PRISE UK UK SOCKET KIT</p> 	125 250	3V5286	kit 1 prise 1 socket kit	seul pour UK for UK only
	125 250	3V5287	kit 2 prises 2 sockets kit	
mission: MKT	Code:QAP000101A	Rev.: 0	Date: 23.09.09	Chapitre/Chapter: 3

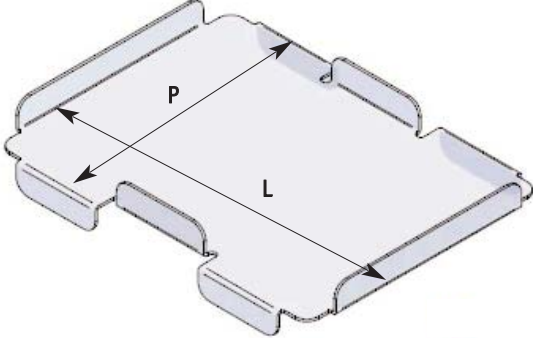
MAXIMA MODULAR PS (pastry)

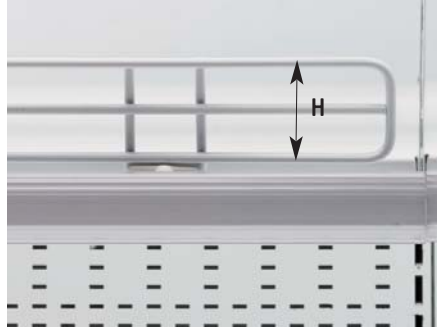
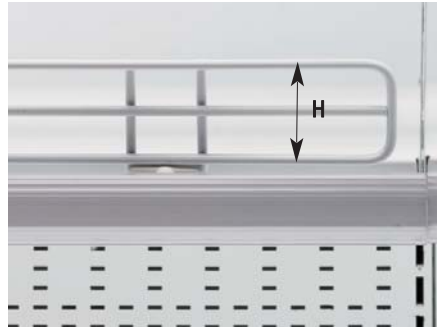
PHOTO/DRAWING	USAGE/USE		Dimensions Dimensions	NOTES
	Long./Lenght	Code		
<p>KIT SUPPORT PAPIER (40X27 TABLETTE AR. 300 mm) PAPER HOLDER (40X27 REAR SHELF 300 mm)</p> 	<p>125 250</p>	<p>3V5519</p>	<p>LxP (mm) 460x360</p>	
.mission: MKT	Code:QAP000101A	Rev.: 0	Date: 23.09.09	Chapitre/Chapter: 6

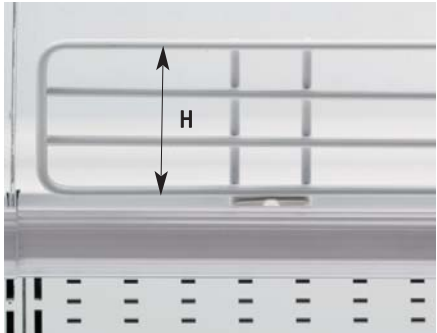
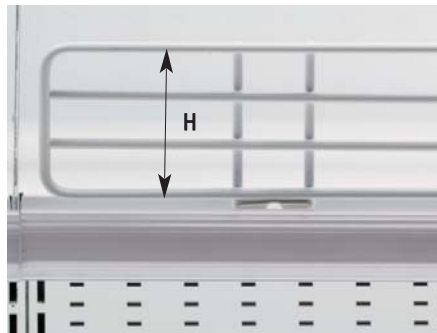
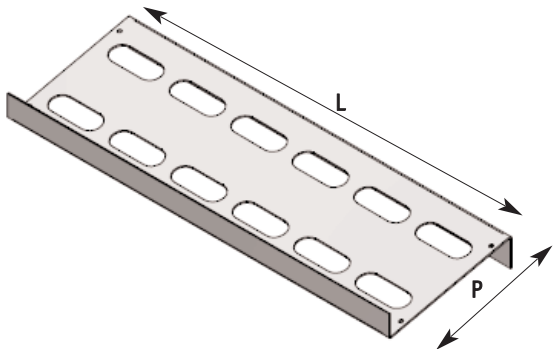
PHOTO/DRAWING	USAGE/USE		Dimensions Dimensions	NOTES
	Long./Lenght	Code		
<p>ARRETE PRODUIT PLEXI H50 TRANSPARENT STOP PRODUCTS H50</p> 	<p>125</p> <p>187</p> <p>250</p>	<p>3V7294</p> <p>3V7284</p> <p>3V7294</p>	<p>H = 50 mm</p>	
<p>ARRETE PRODUIT FIL H50 WIRE RISER H50</p> 	<p>125</p> <p>187</p> <p>250</p>	<p>3V2752</p> <p>3V2751</p> <p>3V2752</p>	<p>H = 50 mm</p>	
<p>ARRETE PRODUIT FIL H50 COULEUR COLOR WIRE RISER H50</p> 	<p>125</p> <p>187</p> <p>250</p>	<p>3V7295</p> <p>3V7285</p> <p>3V7295</p>	<p>H = 50 mm</p>	
<p>ARRETE PRODUIT PLEXI H80 TRANSPARENT STOP PRODUCTS H80</p> 	<p>125</p> <p>187</p> <p>250</p>	<p>2V0322</p> <p>2V0321</p> <p>2V0322</p>	<p>H = 80 mm</p>	
<p>mission: MKT</p>	<p>Code:QAP000101A</p>	<p>Rev.: 0</p>	<p>Date: 23.09.09</p>	<p>Chapitre/Chapter: 7</p>

PHOTO/DRAWING	USAGE/USE		Dimensions Dimensions	NOTES
	Long./Lenght	Code		
ARRETE PRODUIT FIL H80 WIRE PRODUCT STOPPER H80 	125 187 250	2V0292 2V0291 2V0292	H = 80 mm	
ARRETE PRODUIT FIL H80 COULEUR COLOUR WIRE PRODUCT STOPPER H80 	125 187 250	2V0302 2V0301 2V0301	H = 80 mm	
KIT HAUSSE PRODUIT RISE PRODUCT KIT 	125 187 250	3V5518	LxP (mm) 260x225	
RIDEAU DE NUIT MANUEL MANUAL NIGHT BLIND 	125 187 250	3V7322 3V7324 3V7326		
.mission: MKT	Code:QAP000101A	Rev.: 0	Date: 23.09.09	Chapitre/Chapter: 7

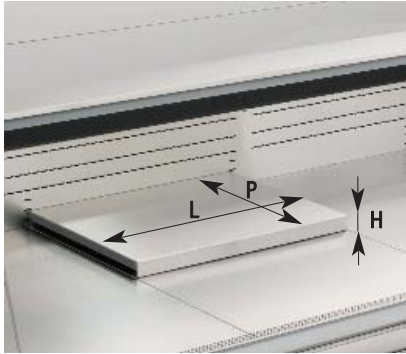
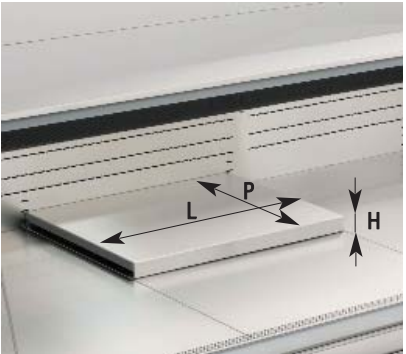
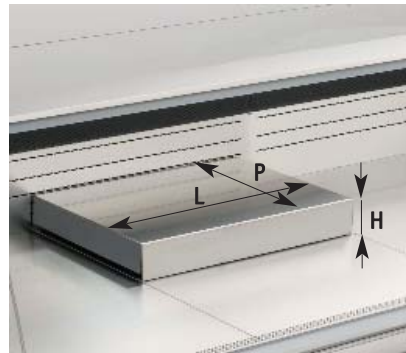
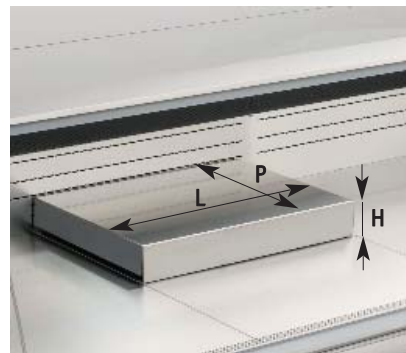

PHOTO/DRAWING	USAGE/USE		Dimensions Dimensions	NOTES
	Long./Lenght	Code		
<p>PLATEAU INOX 2NIV. H40 ST. STEEL DISPLAY TRAY 2L H40</p> 	<p>125</p> <p>187</p> <p>250</p>	<p>3M1478</p> <p>3M1478</p> <p>3M1478</p>	<p>LxPxH (mm)</p> <p>620x420x40</p>	<p>kit 125 step 125 kit</p>
<p>PLATEAU PEINT 2NIV. H40 PAINTED DISPLAY TRAY 2L H40</p> 	<p>125</p> <p>187</p> <p>250</p>	<p>3M3128</p> <p>3M3128</p> <p>3M3128</p>	<p>LxPxH (mm)</p> <p>620x420x40</p>	<p>kit 125 step 125 kit</p>
<p>PLATEAU INOX 2NIV. H90 ST. STEEL DISPLAY TRAY 2L H90</p> 	<p>125</p> <p>187</p> <p>250</p>	<p>3M1488</p> <p>3M1488</p> <p>3M1488</p>	<p>LxPxH (mm)</p> <p>620x420x40</p>	<p>kit 125 step 125 kit</p>
<p>PLATEAU PEINT 2NIV. H90 PAINTED DISPLAY TRAY 2L H90</p> 	<p>125</p> <p>187</p> <p>250</p>	<p>3M3138</p> <p>3M3138</p> <p>3M3138</p>	<p>LxPxH (mm)</p> <p>620x420x40</p>	<p>kit 125 step 125 kit</p>
<p>mission: MKT</p>	<p>Code:QAP000101A</p>	<p>Rev.: 0</p>	<p>Date: 23.09.09</p>	<p>Chapitre/Chapter: 7</p>

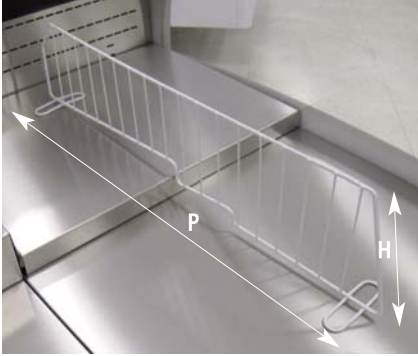
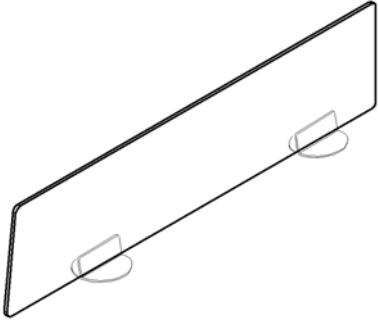
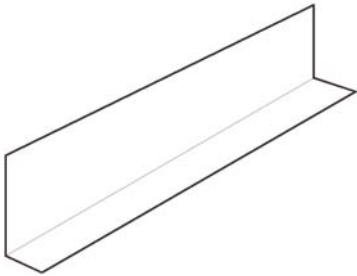
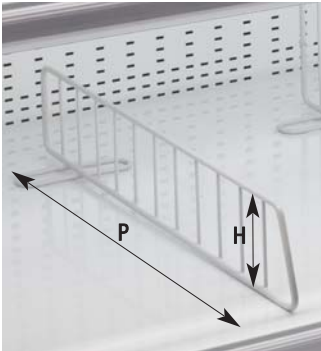

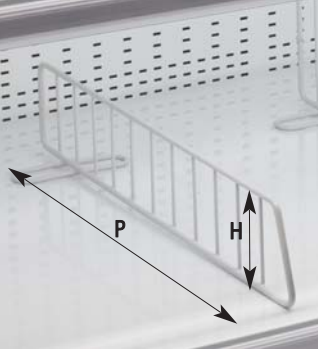
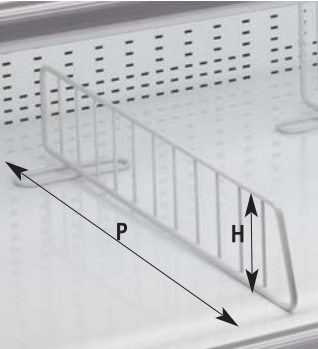
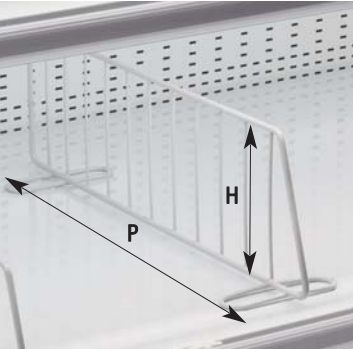
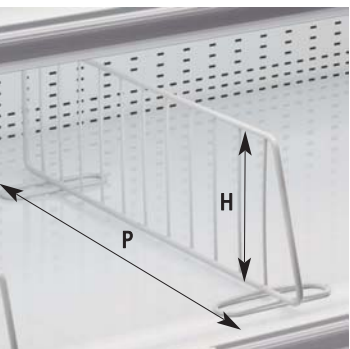
PHOTO/DRAWING	USAGE/USE		Dimensions Dimensions	NOTES
	Long./Lenght	Code		
<p>PLATEAU INOX 3NIV. ST. STEEL DISPLAY TRAY 3L</p> 	<p>125</p> <p>187</p> <p>250</p>	<p>3M1498</p> <p>3M1498</p> <p>3M1498</p>	<p>LxPxH (mm)</p> <p>620x280x35</p> <p>620x280x75</p>	<p>kit 125</p> <p>step 125 kit</p>
<p>PLATEAU PEINT 3NIV. PAINTED DISPLAY TRAY 3L</p> 	<p>125</p> <p>187</p> <p>250</p>	<p>3M3148</p> <p>3M3148</p> <p>3M3148</p>	<p>LxPxH (mm)</p> <p>620x280x35</p> <p>620x280x75</p>	<p>kit 125</p> <p>step 125 kit</p>
<p>SEPARATION BASSE EN VERRE H200 LOW GLASS DIVIDER H200</p> 	<p>TT</p>	<p>3V4889</p>	<p>PxH (mm)</p> <p>830x200</p>	
<p>SEPARATION FIL PLASTIFI...LS WIRE DIVIDER LS</p> 	<p>TT</p>	<p>blanche/white</p> <p>3M1064</p> <p>couleur/colour</p>	<p>PxH (mm)</p> <p>790x195</p>	
<p>mission: MKT</p>	<p>Code:QAP000101A</p>	<p>Rev.: 0</p>	<p>Date: 23.09.09</p>	<p>Chapitre/Chapter: 7</p>

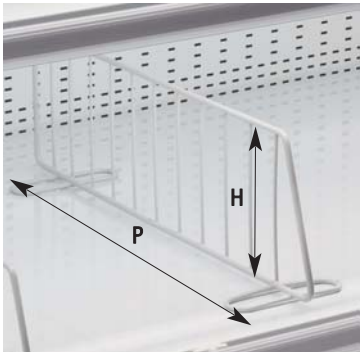
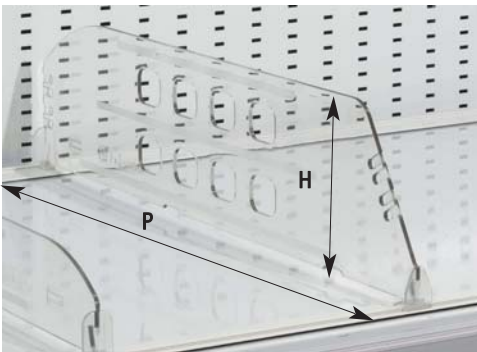
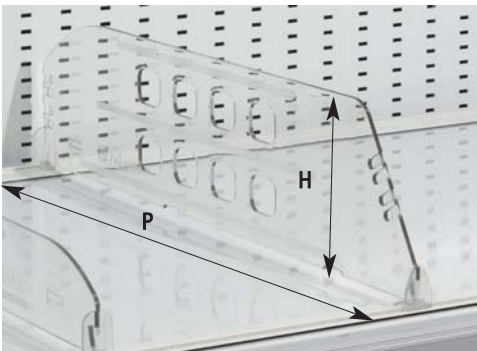
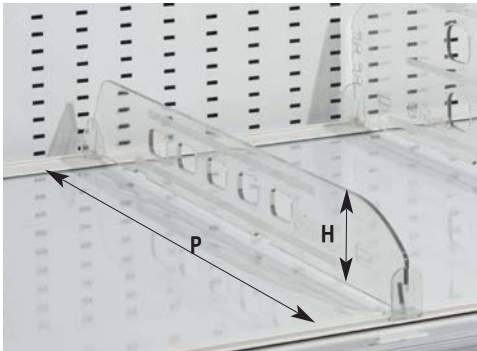
PHOTO/DRAWING	USAGE/USE		Dimensions Dimensions	NOTES
	Long./Lenght	Code		
<p>SEPARATION 2-3 NIV. FIL PLASTIFIE WIRE PAINTED DIVIDER 2-3 LEVELS</p> 	<p>125 187 250</p>	<p>blanche/white 3V5510 couleur/colou</p>	<p>PxH (mm) 710x195</p>	
<p>SEPARATION PLEXI 790x195 PLEXI DIVIDER 790x195</p> 	<p>125 187 250</p>	<p>3M5260</p>	<p>PxH (mm) 790x195</p>	
<p>SEPARATION PLEXI l 835x150 PLEXI DIVIDER l 835x150</p> 	<p>125 187 250</p>	<p>3M5410</p>	<p>PxH (mm) 835x150</p>	
<p>SEPARATION FIL POUR ETAGERES 310x90 WIRE SHELF DIVIDER 310x90</p> 	<p>125 187 250</p>	<p>blanche/white 2V2470 couleur/colou</p>	<p>PxH (mm) 290x90</p>	
<p>mission: MKT</p>	<p>Code:QAP000101A</p>	<p>Rev.: 0</p>	<p>Date: 23.09.09</p>	<p>Chapitre/Chapter: 7</p>

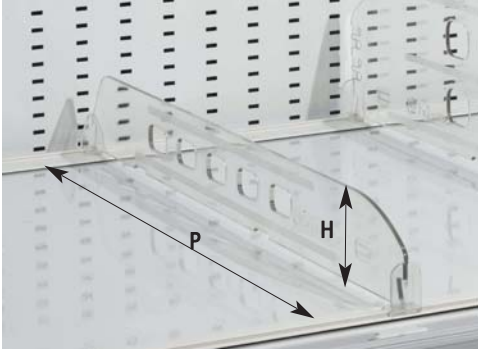
PHOTO/DRAWING	USAGE/USE		Dimensions Dimensions	NOTES
	Long./Lenght	Code		
<p>SEPARATION FIL POUR ETAGERES 410x90 BNC WIRE SHELF DIVIDER 410X90 W</p> 	<p>125</p> <p>187</p> <p>250</p>	<p>blanche/white e 2V2471</p> <p>couleur/colour</p>	<p>PxH (mm)</p> <p>390x90</p>	
<p>SEPARATION FIL POUR ETAGERES 510x90 BNC WIRE SHELF DIVIDER 510X90 W</p> 	<p>125</p> <p>187</p> <p>250</p>	<p>blanche/white e 2V2472</p> <p>couleur/colour</p>	<p>PxH (mm)</p> <p>490x90</p>	
<p>SEPARATION FIL POUR ETAGERES 310x150 WIRE SHELF DIVIDER 310X150</p> 	<p>125</p> <p>187</p> <p>250</p>	<p>blanche/white e 2V2480</p> <p>couleur/colour</p>	<p>PxH (mm)</p> <p>290x150</p>	
<p>SEPARATION FIL POUR ETAGERES 410x150 WIRE SHELF DIVIDER 410X150</p> 	<p>125</p> <p>187</p> <p>250</p>	<p>blanche/white e 2V2481</p> <p>couleur/colour</p>	<p>PxH (mm)</p> <p>390x150</p>	
<p>mission: MKT</p>	<p>Code:QAP000101A</p>	<p>Rev.: 0</p>	<p>Date: 23.09.09</p>	<p>Chapitre/Chapter: 7</p>

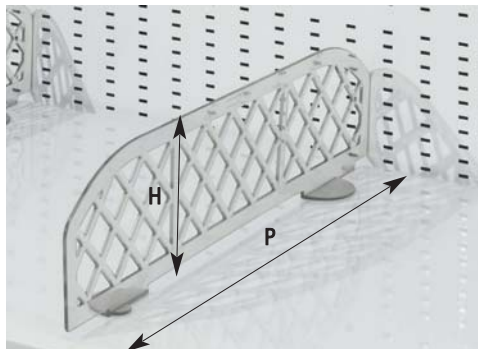
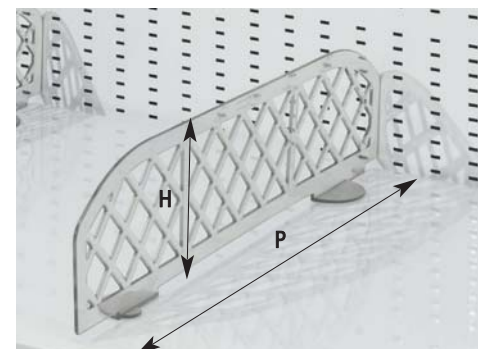
PHOTO/DRAWING	USAGE/USE		Dimensions Dimensions	NOTES
	Long./Lenght	Code		
SEPARATION FIL POUR ETAGERES 510x150 WIRE SHELF DIVIDER 510X150 	125 187 250	blanche/white 2V2482 couleur/colour	PxH (mm) 490x150	
SEPARATION ECO POUR ETAGERES H120 400 SHELF DIVIDER ECO H120 400 	125 187 250	2V2524	PxH (mm) 400x150	
SEPARATION ECO POUR ETAGERES H120 500 SHELF DIVIDER ECO H120 500 	125 187 250	2V2525	PxH (mm) 500x150	
SEPARATION ECO POUR ETAGERES H60 400 SHELF DIVIDER ECO H60 400 	125 187 250	2V2528	PxH (mm) 400x150	
.mission: MKT	Code:QAP000101A	Rev.: 0	Date: 23.09.09	Chapitre/Chapter: 7

PHOTO/DRAWING	USAGE/USE		Dimensions Dimensions	NOTES
	Long./Lenght	Code		
<p>SEPARATION ECO H60 500 DIVIDER ECO H60 500</p> 	<p>125</p> <p>187</p> <p>250</p>	<p>2V2529</p>	<p>PxH (mm)</p> <p>500x150</p>	
<p>SUPPORT MAGNETIQUE POUR SEPARATIONS MAGNETIC SUPPORT FOR DIVIDERS</p> 	<p>125</p> <p>187</p> <p>250</p>	<p>2V3002</p> <p>2V3001</p> <p>2V3002</p>		
<p>SEPARATION ECO AVEC PIEDS H120 400 SELF-STANDING ECO DIVEDER H120 400</p> 	<p>125</p> <p>187</p> <p>250</p>	<p>2V2904</p> <p>2V2904</p> <p>2V2904</p>	<p>PxH (mm)</p> <p>400x120</p>	
<p>SEPARATION ECO AVEC PIEDSE H120 500 SELF-STANDING ECO DIVEDER H120 500</p> 	<p>125</p> <p>187</p> <p>250</p>	<p>2V2905</p> <p>2V2905</p> <p>2V2905</p>	<p>PxH (mm)</p> <p>500x120</p>	
<p>mission: MKT</p>	<p>Code:QAP000101A</p>	<p>Rev.: 0</p>	<p>Date: 23.09.09</p>	<p>Chapitre/Chapter: 7</p>

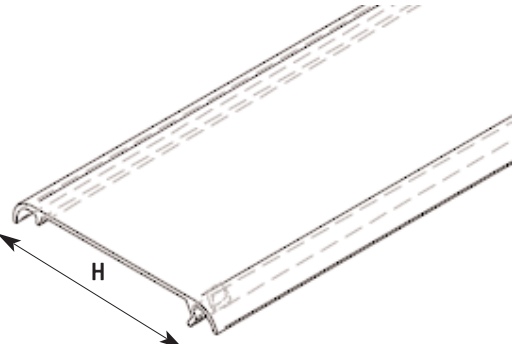
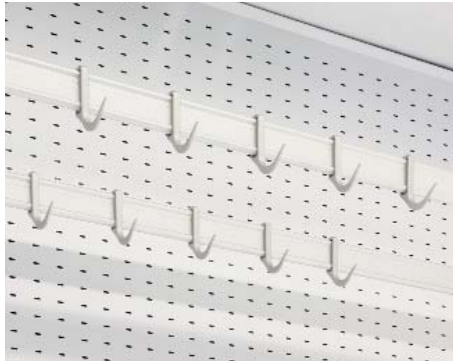
PHOTO/DRAWING	USAGE/USE		Dimensions Dimensions	NOTES
	Long./Lenght	Code		
CLAYETTE DE CUVE LS PLASTICIZED BOTTOM GRILLES LS 	125 187 250	3M1092 3M1094 3M1096	LxP (mm) 615x840	seul LS LS only
CLAYETTE DE CUVE COULEUR LS PAINTED BOTTOM GRILLES LS 	125 187 250	3M2192 3M2194 3M2196	LxP (mm) 615x840	seul LS LS only
COUVERTURE PORTE AFFICHETTE V.C. TICKET HOLDER COVER V.C. 	125 187 250	3V1832 3V1824 3V1826	H = 52 mm	
BARRE A CROCHETS BAR WITH HOOKS 	125 187 250	2M2052 2M2051 2M2052		quantité quantity 1 2 2
.mission: MKT	Code:QAP000101A	Rev.: 0	Date: 23.09.09	Chapitre/Chapter: 7

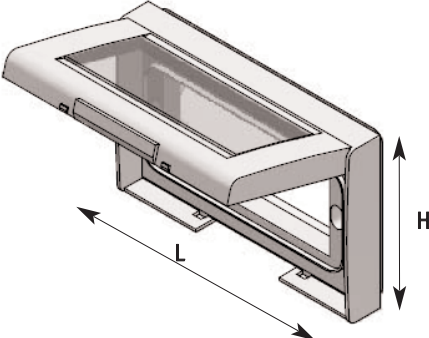
PHOTO/DRAWING	USAGE/USE		Dimensions Dimensions	NOTES
	Long./Lenght	Code		
<p>PROTECTION INTERRUPTEURS IP55 IP55 SWITCH PROTECTION</p> 	125	3M3729	LxH (mm)	
	187	3M3729	140x90	
	250	3M3729		
.mission: MKT	Code:QAP000101A	Rev.: 0	Date: 23.09.09	Chapitre/Chapter: 7